

ISSF Book of New Applications 2020





Contents

The Four Types of Stainless Steel Surfaces

Architecture, Building and Construction

Governador Plácido Castelo Stadium - Castelão Arena
 Ritz Carlton Hotel in Kyoto
 Showerbooths of the Grand Hyatt in Fukuoka
 GINZA SIX
 Flap-Gate type seawall against flood disaster
 Toride Naruto
 "Perfect Roof" of High-purity ferritic stainless steel
 Heisei Chishinkan of Kyoto National Museum
 Stainless steel cladding for housing project (Paris)
 Stainless steel cladding for housing project (Nantes)
 Stainless steel in rehabilitation of historical heritage
 Seismic brace for Stainless steel pipe
 Lining for flue duct
 Façade of Liverpool Plaza Toreo Department Store
 Fukuoka Bar Association Hall

Infrastructure

Application of ferritic stainless steel rebar for bridge construction
 Nakameguro Ventilation Plant installed along the Chuo loop of the Tokyo Metropolitan Highway
 Application of alloy-saving duplex stainless steel plate for dams/floodgates
 Pedestrian and bicycle bridge concept in duplex stainless steel
 Wynyard Walk
 Waterfront, Shell Cove
 NS Cover Plate
 Stainless steel band for fixing pipes
 Stainless steel supplies for pigpens
 Extension of Monaco to the sea
 Stainless steel highway sound barriers
 Brescia metro stations
 First use of duplex stainless steel Forta LDX 2404, UNS S82441 in a major bridge building project
 The sediment discharging facility at the Biratori Dam
 The lock gates of Miyako city ferry terminal
 Façade of interior pedestrian hall at Mexico City International Airport
 Municipal water storage tanks manufactured in 3CR12 instead of concrete
 Application development of stainless steel in reservoir
 Water supply tank in Yonago
 Stainless steel lined water reservoir
 Metal support for ventilation duct used in the work on ventilation equipment for the underground flood control reservoir in the Furukawa river (no. 1)
 Innovative modular concept for wastewater treatment tanks
 C 2 Fresh Water



Domestic appliances

Black Stainless steel for premium appliances
 Development of PossFD for refrigerant piping
 Stainless steel for Hard Disk Drive (HDD) cover
 A box for home delivery

Automotive

Transportation container in high-chromium Austenitic 316plus
 Diffusion bonded compact heat exchanger made of austenitic stainless steel
 Non-coated stainless steel bipolar plate for hydrogen fuel cell vehicle
 Hydrogen fueling receptacle in the Toyota MIRAI fuel cell vehicle
 Grommet gasket for innovative diesel engine
 Turbine housing (CK-SMiTH)
 MaX: Ultra-High Strength stainless steel for body in white and chassis applications
 Exhaust Gas Recirculation (EGR) Pre-Cooler
 Leisure and commercial hardtop storage solutions
 Lightweight stainless steel fuel filler neck for automobiles
 Ferritic stainless steel with enhanced formability for exhaust systems of hybrid and plug-in hybrid vehicles
 Folded stainless steels create a new concept in bend-formed body structures for small electrified urban vehicles

Food and beverage production

Stainless Steel RDA Units
 Manufacture of biomass stoves and potskirts
 ABACO Anti-bacterial coating
 Stainless steel bottles
 Solar drier
 Stainless steel trays instead of disposable containers in the school dining halls
 NDF 250-man Mobile Kitchen
 Martensitic stainless steel for knife blades and cutting tools

Electrical Machinery

3CR12 Substations
 Residential energy storage system
 Stainless steel electrical enclosures

Green energy production

Biomass wagons
 Application of Stainless Steel for Dori-kamu Foundation-Making Method (Foundations for Solar Panel Mounts)
 Collector electrode



Industrial Machinery

Intermediate bulk container mixer systems
Anderson Contramix
Anderson and Pure Magnetic Mixer
Ferrochromium fines treatment centre
Corrodur 18 – a new martensitic medium nitrogen stainless steel grade for bearing applications
Fuchs Lubricants Australasia purpose-built plant
Retainers made with high-purity ferritic stainless steel wire
Stainless steel container for mining
Therma grade for a baking furnace used to produce catalysts for oil refining
Stainless steel floor for garbage truck hoppers
Concrete mixer truck

Transport

Sailboat KAT - Schurmann Family
Stainless steel yacht
SOx scrubber tower
Conveyor belt self unloading stainless steel trailers
Stainless steel yacht
Stainless steel power pack
Stainless steel bicycle

Other

Stainless weldable sandwich with 3D-profiled core
Shark Rover submersible
High Nitrogen (above 2000ppm) and Low Nickel (~3.0%) alloyed High Strength Austenite Stainless Steel (QN1803/304D) with no less Pitting Corrosion Resistance than standard 304
Urban waste sorting/recovery container
Stainless steel floors for bumper cars
Stainless steel new applications in Nigeria
RFID applied stainless steel food waste measuring & paying equipment
Stainless steel leading the way to a safe and sustainable future
SP-JOINT fire plug granular tee, customized fire pipe multi-joint tee
KAGRA, Large-scale Cryogenic Gravitational-wave Telescope of Japan



The Four Types of Stainless Steel

Austenitic

Austenitic stainless steels contain a significant amount of chromium, and sufficient nickel or manganese to stabilise the austenite microstructure that gives these steels good formability and ductility (and makes them non-magnetic). A typical composition is 18% chromium and 8% nickel, as found in the popular AISI 304 grade. (AISI is an abbreviation of American Iron and Steel Institute and is commonly used as a grade designation.) Austenitic grades can be highly durable and corrosion resistant and have high ductility, low yield stress, relatively high tensile strength and good weldability. They have a very wide range of uses.

Ferritic

Ferritic stainless steels have properties similar to those of mild steel but show better corrosion resistance. Most common are 11% and 16% chromium containing grades – the former used mostly in vehicle exhaust systems and the latter mostly in cooking utensils, washing machines and Indoor architecture.

Austenitic-Ferritic (Duplex)

These stainless steels, which contain high chromium and some nickel, have a microstructure that is roughly 50% ferritic and 50% austenitic. They are mostly used in the process industry and in seawater applications.

Martensitic

Like ferritic grades, martensitic grades contain 12 to 16% chromium. However, they have higher carbon content and are subjected to specific heat treatments during production, making them very hard and strong. They are used in applications such as turbine blades, cutlery and razor blades.

Surfaces

Surface finishing treatments applied to stainless steels can take many forms. The main finishes are described below. Ferritic surface finishes are the same as those for austenitic and other grades.

Description	ASTM	EN10088-2	Notes
Hot rolled	1	1E/1D	A comparatively rough, dull surface produced by hot rolling to the specified thickness, followed by annealing and descaling.
Cold rolled	2D	2D	A dull, cold rolled finish produced by cold rolling to the specified thickness, followed by annealing and descaling. May also be achieved by a final light pass on dull rolls.
Cold rolled	2B	2B	A bright, cold rolled finish commonly produced in the same way as No. 2D finish, except that the annealed and descaled sheet receives a final cold roll pass on polished rolls. This is a general-purpose cold rolled finish and is more readily polished than No. 1 or No. 2D.

Description	ASTM	EN10088-2	Notes
Bright annealed	BA	2R	BA finish produced by performing bright annealing in an inert atmosphere after cold rolling. Smoother and brighter than No. 2B.
Brushed or polished	No. 4	1J/2J	A general-purpose bright polished finish obtained by finishing with a 120-150 mesh abrasive, following initial grinding with coarser abrasives.
Satin polished (mat)	No. 6	1K/2K	A soft satin finish having lower reflectivity than brushed finish. It is produced by using a medium abrasive.
Bright polished (mirror)	No. 8	1P/2P	The most reflective finish commonly produced. It is obtained by polishing with successively finer abrasives then buffing with a very fine buffing compound.
Electropolished	-	-	This surface is produced by electrolysis in an electrolytic solution. This electrochemical process improves the surface finish.



2D



2B



BA



no. 4



no.6

Architecture, Building and Construction

Governador Plácido Castelo Stadium - Castelão Arena

The stadium in Fortaleza city in the North East of Brazil, called Castelão, hosted 6 World Cup matches. This stadium for 64,000 persons went through two years of refurbishments. The project was led by a Brazilian architecture office, Vigliecca & Associados. The façade was entirely made using stainless steel expanded sheets. In addition to the external frame, stainless steel was used on railings, handrails at VIP areas, lavatories and locks of the stadium. "We have made an option for the durability stainless steel provides, which is essential to areas like the façade that required a corrosion-resistant material, and for its noble appearance, required in the hospitality sector", says architect Ronald Fiedler, responsible for the Project.



Name of member:
Aperam
Manufacturer:
Martifer/Permetal
Location:
Brazil
Environment:
outdoor
Grade and surface:
444/2B
Quantity:
80 tonnes

Architecture, Building and Construction

Ritz Carlton Hotel in Kyoto

Ritz-Carlton Hotel Kyoto is located near the Nijo-Ohashi Bridge crossing the Kamogawa River in Kyoto and creates an extremely refined atmosphere where modernity and tradition fuse.

Kyoto, with 17 world heritage sites, has strict landscape ordinances regulating the heights and designs of buildings. Against this background, the hotel's roof is patterned after Japan's traditional building technique of Sukiya-construction. The ferritic SUS445J2 sand-blasted provides a "mattlooking finish". The rectilinear roof and eave with horizontally-laid panels blend nicely in the landscape facing thirty mountains of Higashiyama, harmonize with the townscape of Kyoto and are well appreciated by hotel guests and strollers. The parties concerned worked and succeeded in sandblasting the ferritic stainless steel roofing of 0.4mm in thickness, which had been previously deemed difficult, and in meeting requirements of various parties including the owner, designer and builder. The parties have contributed in providing the Hotel with flavors of genuine Japanese architecture to match the city of Kyoto.



Picture courtesy of Japan Stainless Steel Association.



Name of Member:

NIPPON STEEL
Stainless Steel
Corporation

Manufacturer:

GANTAN Beauty
Industry Co.Ltd.

Location:

Kyoto, Japan

Environment:

urban

Grade and surface:

SUS445J2 (NSS U-22),
dull

Architecture, Building and Construction

Showerbooths of the Grand Hyatt in Fukuoka

Alloy-saving stainless steel NSSCFW2 was used for shower booths of Grand Hyatt Fukuoka, one of the high-end hotel Fukuoka City.

This NSSC's original stainless steel, containing just 16% chromium only and no nickel, being added micro amount of tin can achieve the corrosion resistance equivalent to SUS304. The polished surface of NSSCFW2 is characteristic silvery-white color, which cannot be achieved by other stainless steel grades. It is also effective for nickel allergy. Toyo Stainless Polish Industry Co., Ltd. uses and owns unique polishing techniques which are one of the key elements for receiving an award. The surface finish is called "Powder Snow" which

reduces glare and has a three-dimensional impression with inhomogeneity. In addition, "MD treatment", a special treatment to harden the surface and usually used on the countertops of high-end kitchens, was applied on the surface. The treatment can bring better scratch resistance against water washing brackets. Thus, it was applied for the famed hotel in Fukuoka, as the material was highly evaluated because of the advantages of the alloy-saving stainless steel, designed polishing, and treatment to suit to the usage environment.



Pictures courtesy of NSSC.



Name of Member:
NIPPON STEEL
Stainless Steel
Corporation
Manufacturer:
Toyo Stainless Polish
Industry Co. Ltd.
Location:
Fukuoka, Japan
Environment:
Indoor
Grade and surface:
NSSC®FW2 Powder
Snow finish

Architecture, Building and Construction

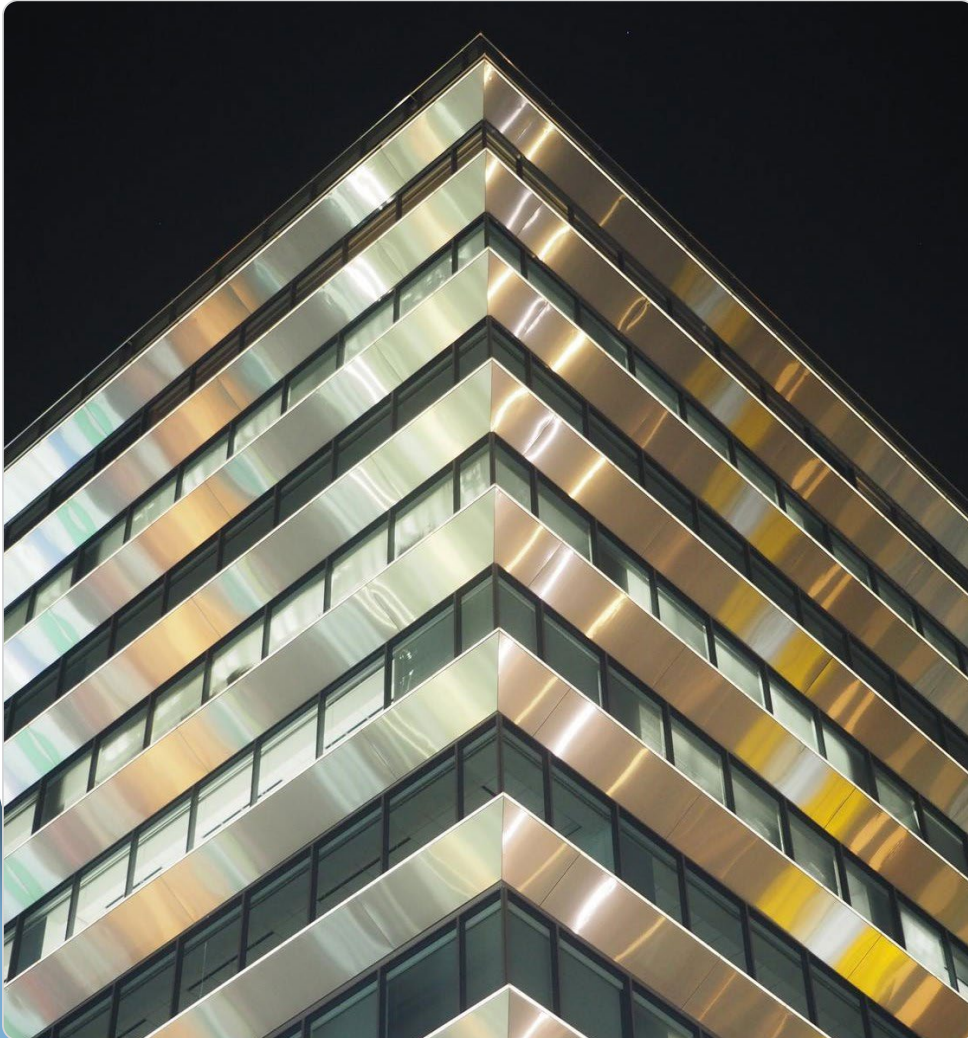

Pictures courtesy of NSSC.

GINZA SIX

GINZA SIX was designed by internationally acclaimed architectural firm Taniguchi and Associates and Kajima Corporation as a redevelopment project of two blocks in Tokyo's Ginza upscale neighborhood. The building, which has 13 floors above ground and 6 floors underground, was constructed by Kajima Corporation, with a total area of 148,000 square meters. For the trademark eaves of the building, which can be seen from a distance, Mitsubishi Chemical Corporation's stainless steel composite material "ALPOLIC/fr®SCM" which uses NSSC®220M was applied. This ferritic stainless steel has excellent rust-resistance (superior to SUS316) and a lower thermal expansion coefficient. The building is recognized as the new symbol of Ginza, one of the most famous areas for shopping and sightseeing in Japan.

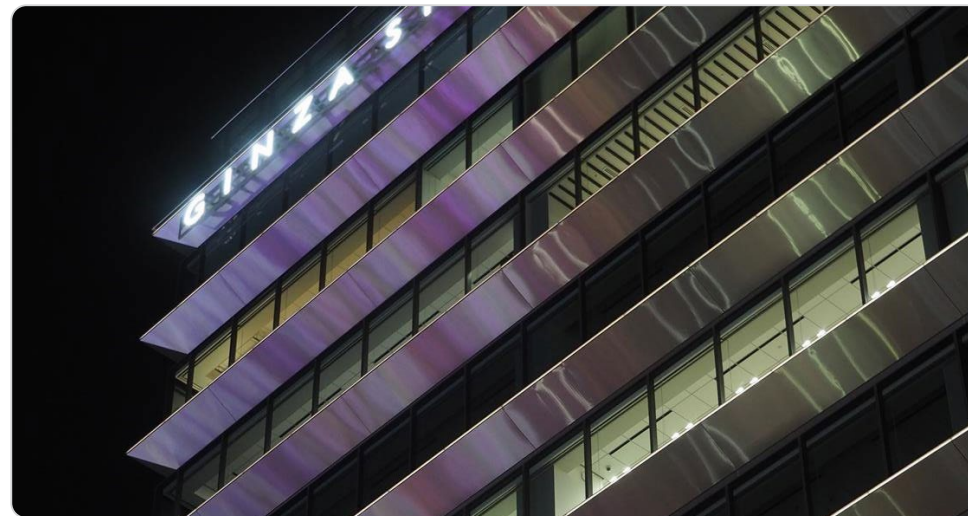

Name of Member:
NIPPON STEEL
Stainless Steel
Corporation
Manufacturer:
Mitsubishi Chemical
Corporation
Location:
Tokyo, Japan
Environment:
outdoor
Grade/surface:
NSSC®220M (22Cr-
1.6Mo-LC, N), hairline
polished finish

Architecture, Building and Construction

Flap-Gate type seawall against flood disaster

Before the Great East Japan Earthquake in 2011, aluminum-alloy slide gates had been one of the main countermeasures against tsunamis, however the adoption of a new technology called "Flap-Gate" has been advanced after the disaster. When tsunami comes, the gate stored in the ground at normal time rises by its buoyancy with no electricity to prevent it. It was originally applied for small gates which were installed at the doorway of buildings to prevent from flood, and now it has been applied for countermeasures against tsunamis. There were three major requirements for the main material to materialize the Flap-Gate Type Seawall. Firstly, as large vehicles pass over the gate, it has to have high strength against deformation and abrasion resistance. Secondly, high corrosion resistance was required to reduce the painting and repairing cost. Thirdly, the material has to be

light enough to enable the gates to flip up by its buoyancy. The features of NSSC2120 could give solutions to these requirements. This lean duplex stainless steel contributed to the implementation of Flap-Gate Type Seawalls against flood disaster, by improving durability and corrosion resistance, and reducing weight simultaneously. The largest seawall whose size was 60m³ was constructed. More than 1,200 tons of stainless steel has already been used for this usage in Japan, and the total domestic demand is estimated to be 5,000 tons. Moreover, these gates are now considered to be installed in Southeast Asian countries, as countermeasures against the sea level rise caused by climate change.



Pictures courtesy of Japan Stainless Steel Association.



Name of Member:
NIPPON STEEL
Stainless Steel
Corporation
Manufacturer:
Hitachi Zosen
Corporation
Location:
Japan
Environment:
outdoor
Grade and surface:
NSSC2120®
(ASTM S8122)

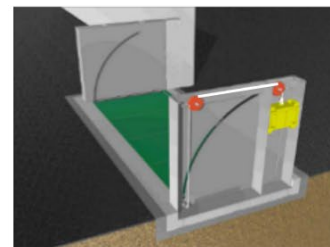

Normal position

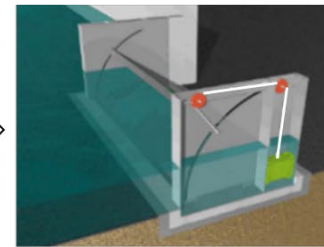
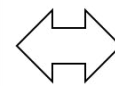

Rising start

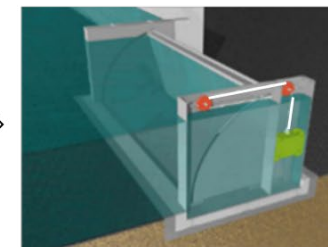
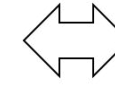

Highest water level

Architecture, Building and Construction

Toride Naruto



Pictures courtesy of Japan Stainless Steel Association

This is a Japanese traditional fortress castle ruin and this three-layered tower used as a memorial museum of Mr. Torii who is an anthropologist. The museum was closed in 2010 due to its need for renovation and reopened with the earthquake-proof construction in 2016 as a free conference room and shelter for citizens. Then, it is nicknamed "TORIDE comes to". Formerly known as "Mr. Torii's museum", it will become to a "TORIDE" means a fortress for region and citizens.

In order to ensure the earthquake resistance performance of the building, press-formed metal roof tiles which do not burden the structural frame by 1/10th the weight of clay roof tiles are adopted as materials for roof repair work. The Toughen Z was selected, hot-dip galvanized stainless steel plate of SUS 430, it has both corrosion resistance of stainless steel and antirust effect of hot-dip galvanizing. It is a decorative roof and exterior material which has been subjected to hot-dip galvanizing with a calm appearance, exhibits a tone of gradation by chemical treatment. In accordance with the high earthquake resistant structure, it creates a peculiar atmosphere of the castle and contributes to a new image of stainless steel.



Name of Member:
NIPPON STEEL
Stainless Steel
Corporation
Manufacturer:
GANTAN Beauty
Industry Co. Ltd.
Location:
Naruto City, Japan
Environment:
coastal
Grade and surface:
Toughen Z (hot-dip
galvanized stainless
steel plate of SUS430)

Architecture, Building and Construction

“Perfect Roof” of High-purity ferritic stainless steel

Business climate surrounding the construction industry is getting complicated and varied with soaring materials costs and labor shortage.

The material selection of SUS443J1, a high-purity ferritic grade, for “Perfect Roof” worked to realize such needs of building designers and owners as designability, durability and low cost.

SUS443J1 was registered in the 2013 version of “the standard specifications for public works”, which now enables material suppliers to offer this grade for both public and private works.

In addition, this nickel-free grade is economical and earth-friendly and yet has the corrosion resistance equivalent to that of SUS304.

The adoption of SUS443J1 helps satisfy social needs and will contribute to our society.



Pictures courtesy of Japan Stainless Steel Association



Name of Member:

JSSA

Manufacturer:

E. KATAYAMA &
CO., LTD.

Location:

Japan

Grade and surface:

SUS443J1

Architecture, Building and Construction

Heisei Chishinkan of Kyoto National Museum (Interior and Entrance Section)



Picture courtesy of Japan Stainless Steel Association

In order to have stainless steel used for the interior and the entrance section of Heisei Chishinkan of Kyoto National Museum, high designability to harmonize with the main building was a critical requirement.

As the first step of manufacture, super-flat stainless steel plates were put through a primary surface polishing technique called EGR, then mirror-finished and finally beads-blasted for a “deep tone mirror” finish. These processes have provided an aesthetic appearance befitting the Museum which represents Japan and also has given an expression to harmonize nicely with Japanese-style space creation.

The products were made through technical collaboration of the companies concerned and excel as materials to contribute to the beauty of the building displaying our country's traditional artistic works.

The adoption of the products has expanded the designability potential of stainless steel and has impressed many people with its aesthetic features.



Name of Member:

JSSA

Manufacturer:

Tokyo Stainless
Steel Grinding LTD.,
NIITAKASEISAKUSYO
CO., LTD.

Location:

Kyoto City, Japan

Grade and surface:

SUS304

Architecture, Building and Construction

Stainless steel cladding for housing project

With fewer people owning cars, the once dominant parking garage is no longer king of the city. But instead of simply demolishing these old structures to make way for new projects, innovative architects like Laurent Niget are converting car parks into state-of-the-art apartments. At 151 rue du Faubourg-Poissonnière in Paris, an address once occupied by two Haussmann-style buildings and a parking garage, he has created an architecturally striking housing project. By renovating and repurposing the existing buildings, Laurent Niget was able to create more units than would have been possible with a traditional demolition-reconstruction approach. The result is an industrial-styled building featuring an internal courtyard, exposed concrete beams, and open plan living spaces. Its stainless steel façade, made from Aperam's standing seam stainless steel cladding, gives the historic buildings a futuristic appeal, brings light to the courtyard and perfectly reflects the many trees lining the grounds.

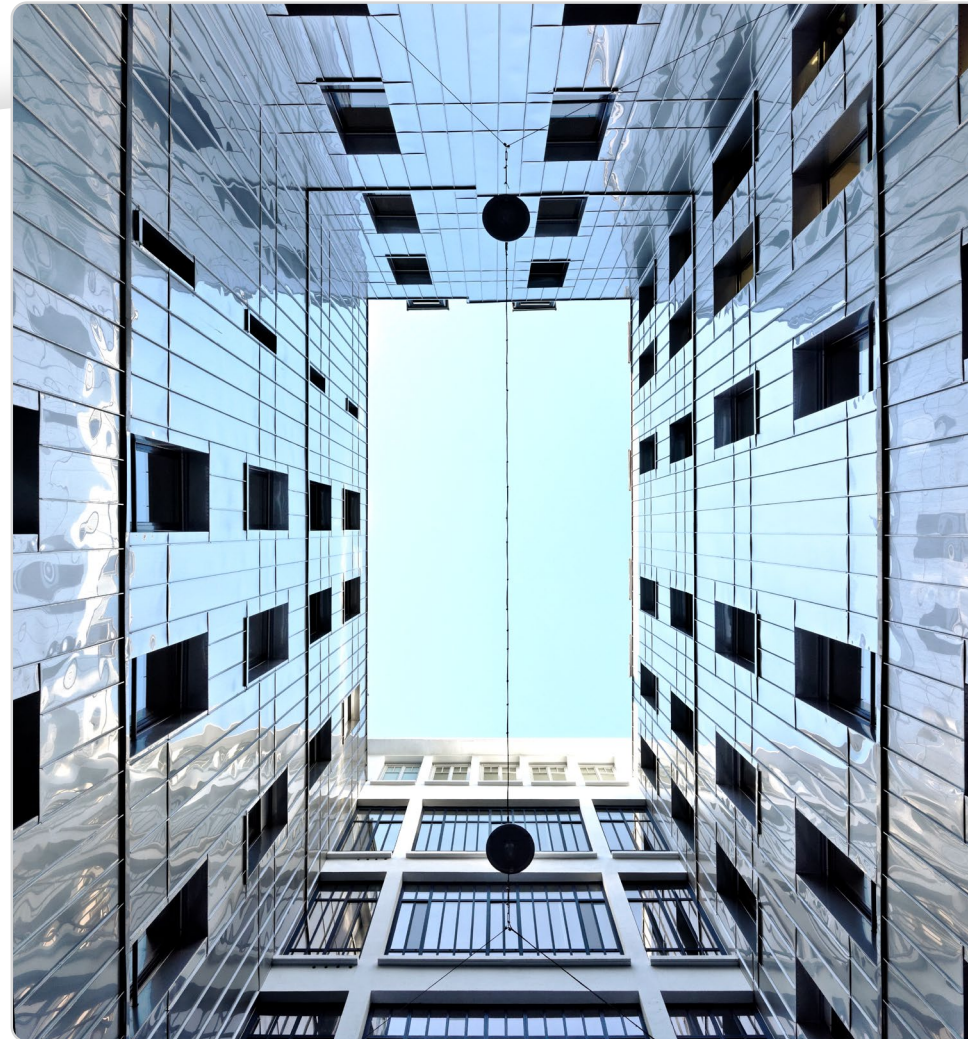

Picture ©David Boureau

**Name of Member:**

Aperam

Manufacturer:

Raimond

Location:

Paris, France

Environment:

outdoor

Grade and surface:

EN 1.4301

(Aperam 304)/

2B (Uginox Mat)

Architecture, Building and Construction

Stainless steel cladding for housing project

Nantes' new Gambetta housing complex features a stainless steel-enhanced façade that mirrors the contemporary while reflecting on the natural. Designed by architect Philippe Dubus, the building brings together 56 social housing units, a nursery, a rehabilitation unit and a number of administrative offices to create a new urban icon in the city's historic center. All of the building's façades are adorned with cladding sheet steel strips and lacquered panels, between which slide screen walls, shutters and stainless steel panels. This unique use of stainless steel resembles a curtain, which not only gives the building a cutting-edge contemporary feel, it also reflects the surrounding forests and natural light. The project, which utilises Aperam's 304L grade with Uginox Bright Finish, won the 2018 Eiffel Trophy for Steel Architecture in the 'Living' category.



Picture ©Sergio Grazia



Name of Member:

Aperam

Manufacturer:

ArcelorMittal
Construction -
Raimond

Location:

Nantes, France

Environment:

outdoor

Grade and surface:

EN 1.4307
(Aperam 304L)/
BA (Uginox Bright)

Architecture, Building and Construction



Stainless steel in rehabilitation of historical heritage

Restoration and rehabilitation means a huge market for stainless steel. Ancient buildings suffer over time and in many cases must be restored. Most of the ancient materials used are porous so that they cannot be restored with carbon steel. Stainless steel provides a long lasting solution for historical heritage restoration. Due to its excellent

properties, assures long durability and fewer interventions. Stainless steel can be used in many forms in this application, for instance as rebar, mesh, angles... among many others. Stainless steel is a perfect example of how a new material can take care of an ancient one.



Pictures courtesy of Acerinox Group



Name of member:

Acerinox

Manufacturer:

Roldan - Acerinox Group

Location:

Seville, Spain

Environment:

urban, rural

Grade and surface:

duplex stainless steel rebar

Competing material:

carbon steel rebar

Architecture, Building and Construction

Seismic brace for Stainless steel pipe

Fire extinguishing pipes must be installed according to the Fire Service Act. However, in the past, there was no seismic brace for stainless steel pipes, so stainless steel pipes could not be used.* The seismic brace for stainless steel pipes was developed to prevent corrosion between dissimilar metals. The fire extinguishing pipe made from stainless steel, now capable of anti-seismic design, can be

widely used in apartment and building construction sites. If stainless steel is used up to the pipe as well as the seismic brace, the actual amount of stainless steel used will increase.

** When carbon steel and stainless steel are contacted, it is necessary to insulate because of intermetallic corrosion.*

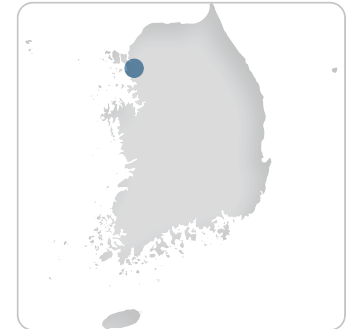

Name of member:

KOSA

Manufacturer:

Justice and peace fire protection engineering company (jpenc.co.kr)

Location:

Incheon, South Korea

Environment:

industrial

Grade and surface:

STS304

Competing material:

galvanized iron

Pictures courtesy of KOSA

Architecture, Building and Construction

Lining for flue duct

Private power generators have attracted a lot of attention to ensure the power in preparation for an emergency such as an earthquake. Stainless steel has been applied to the inner lining of the flue ducts connecting to the generator. Since the temperature of the lining is very high from exhaust gases, a special structure is required to reduce the thermal strain. Ferritic stainless steel with a low thermal expansion coefficient is essential to reduce the thermal strain and it results in relaxation of the special structure. This contributes to the improvement of workability to line the flue duct with stainless steel. SUS443J1 with a low thermal expansion coefficient and excellent corrosion resistance against exhaust gas is considered to be suitable for this use. Therefore we expect that this kind of stainless steel will contribute to the spread of the flue duct market connecting to the private power generator.

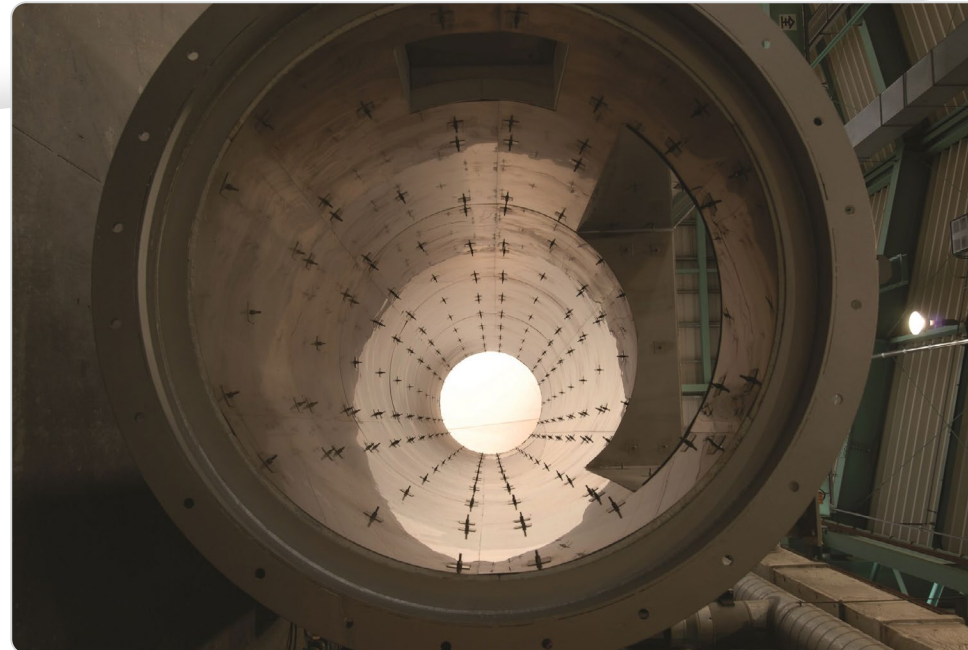

Picture courtesy of Fujimori Sangyo



Name of member:
JFE Steel Corporation
Manufacturer:
Fujimori Sangyo Co.,Ltd
Location:
Japan
Environment:
Industrial
Grade and surface:
SUS443J1 2D (KD)
Competing material:
304

Architecture, Building and Construction

Façade of Liverpool Plaza Toreo Department Store

The façade of the Liverpool Plaza Toreo Department Store is located in the Periferico Freeway, a road that connects Mexico City with Naucalpan, State of Mexico, which is the busiest road in Mexico City. The façade is very visible for drivers that can view the different tones the façade gets depending on the daylight.

The way to assemble, is with a flat-lock system which seems to be fish scales. This technique of mechanical union avoids the use of welding, adhesives, sealants or liquid elements that could fail and stain the façade by draining them. This arrangement makes the façade waterproof since it allows the water to flow freely over the surface without entering the building, guaranteeing the watertightness. Fish scales are visually also very attractive and undoubtedly attract the attention of people passing through the place.

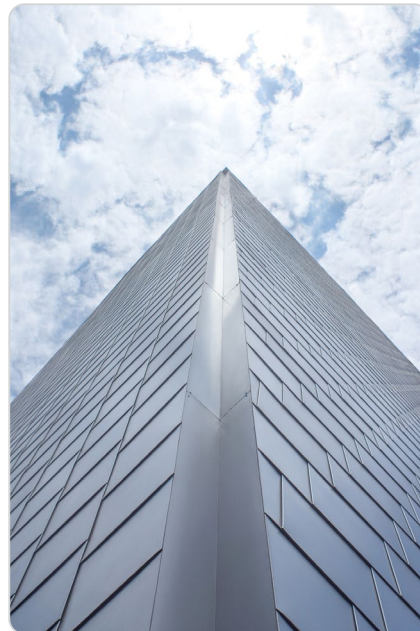

Liverpool Plaza Toreo is the only stainless steel façade of these dimensions in the metropolitan area of Mexico City and the second in the State of Mexico, the first is also of Liverpool Department Store but is located in Interlomas Mall in Huixquilucan State of Mexico. In this way, this façade is a great promoter of stainless in façades, as it is the only one of its kind in Mexico City and located on the busiest road in this city.



Name of member:
IMINOX
Manufacturer:
Grupo Básica
Location:
Naucalpan, Mexico
Environment:
urban
Grade and surface:
316L 2B 24 gauge
Competing materials:
stone and phenolics

Architecture, Building and Construction

Fukuoka Bar Association Hall

“Fukuoka Bar Association Hall” is the first building to be constructed in the redevelopment project of the Tenjin Area of Fukuoka City, the largest city in Kyushu.

It is designed by Mr. Koichi Furumori, an architect who lives in Fukuoka, to express the dignity of lawyers and to be approachable for local citizens. The characteristics of this hall are not only the application of cutting-edge technologies for the structure, but was also the design using stainless steel sheet for both the exterior and the interior.

The surface of the stainless steel sheet is polished to express the design derived from the traditional textile pattern “Hakataori Kenjo-gara”. “Hakataori Kenjo-gara” is originated from the Kenjogara textile, which was proffered, or “Kenjo”, to the Shogun from Fukuoka in the Edo period. The pattern is a series of alternating lines of stripes and lines which are comprised of rhombuses



Name of member:
NIPPON STEEL
Stainless Steel
Corporation
Manufacturer:
Toyo Stainless Polish
Co., Ltd.
Sanwa Tajima
Corporation
Environment:
urban, coastal
Grade and surface:
NSSC220M, 18 tons
and NSSCFW2, 2 tons;
design polished finish

to express buddhist teachings and flower bowls. There are no examples to express Kenjo-gara on buildings with stainless steel. The Furumori Koichi Architectural Design Office, Toyo Stainless Polish Industry Co., Ltd, and NIPPON STEEL Stainless Steel Corporation strived to express the Kenjo-gara pattern by changing the type of polishing on the surface of the stainless steel sheet. The Tenjin area is located close to coast, stainless steel type 304 is frequently used as a material for buildings, and rust can be seen on the surface. Therefore, NIPPON STEEL Stainless Steel Corporation proposed NSSC220M as the exterior of the hall, which has been adopted to several buildings in coastal area due to its excellent rust-resistance. In addition, NSSCFW2, whose polished surface becomes a characteristic silvery-white color which cannot be achieved by other stainless steel grades, is applied to the interior.

Pictures courtesy of Omori Kyoko

Infrastructure

Application of ferritic stainless steel rebar for bridge construction

The Nou Bridge is a concrete road bridge of a coastal road in the West of Japan which had developed severe corrosion in its forcement. Besides the chloride-bearing marine atmosphere, the use of de-icing salts in winter was another cause of the damage. For the refurbishment of the bridge, the selective use of ferritic stainless steel was a rational and cost-saving choice. Out of the four spans of the bridge structure, the exposed outer two needed to be replaced. The new concrete spans were cast on site and reinforced with type SUS410 17 % chromium stainless steel, which ideally fulfilled both the corrosion resistance and cost reduction requirements. While the use of stainless steel reinforcement in new roads and bridges is not uncommon, this case shows that the stainless steel option is also technically and economically viable in repair and renovation.



Pictures courtesy of the Japan Stainless Steel Association.



Name of member:

NIPPON STEEL Stainless Steel Corporation

Manufacturer:

Ministry of Land, Infrastructure, Transport and Tourism Kokuriku Regional Development Bureau / Sumitomo Mitsui Construction Co., Ltd.

Location:

Japan

Environment:

coastal

Grade and surface:

SUS410-SD

Quantity:

60 metric tons

Infrastructure

Nakameguro Ventilation Plant installed along the Chuo loop of the Tokyo Metropolitan Highway

Nakameguro Ventilation Plant of the Tokyo Metropolitan Highway is installed over the tunnel running under the Meguro River and the Yamate Street – a chic section of the City. Since the material for the Plant was required to be aesthetic and durable, a weather-resistant ferritic stainless steel grade was selected. Particularly for louvers and fixtures which are placed at lower parts of the Plant and visible to the public, sand blastfinished SUS445J1 with excellent designability is used and satisfies local residents' request that “the Plant should be harmonious with the surrounding buildings” and “the Plant should also be harmonious with the strolling path along the Meguro River”. In addition, SUS445J1 is adopted for the shutters for the Plant's emergency exits. Nakameguro

Ventilation Plant is located close to Tokyo Bay and therefore exposed to a severely corrosive environment. The shutters need to be reliable and fully operative all the time, and cannot fail due to rust or other causes in case of emergency. The City's infrastructures built half a century ago are now antiquated and repair and renewal works are under way so as to complete their improvement in time for the 2020 Tokyo Olympics/ Paralympics. The adoption of stainless steel for this Plant will serve as an empirical proof of the metal's aesthetic and durable aspects and contribute to upgrade social infrastructures.

Picture courtesy of Japan Stainless Steel Association



Name of Member:
NIPPON STEEL
Stainless Steel
Corporation
Manufacturer:
Kajima Corporation,
Sanwa
Shutter Corporation,
Kikukawa Kogyo
Location:
Tokyo
Environment:
outdoor
Grade and surface:
SUS445J1
Quantity:
31 tons

Infrastructure

Application of alloy-saving duplex stainless steel plate for dams/floodgates

After the Great East Japan Earthquake in 2011, alloy-saving duplex stainless steel (ASDSS) has been used in many projects aiming to improve the resilience of infrastructure facilities against natural disasters.

For example, ASDSS is applied to floodgates used for coastal dike countermeasures against tsunamis. In addition, it is applied to mechanical facilities in dam upgrade countermeasures against heavy rainfalls and electrical power shortages.

Coated carbon steels have been conventional materials for these parts to keep the initial cost down. However, NSSC offered ASDSS because its higher strength enables thickness reduction, which leads to dramatically reduced weight, and huge cost savings. Moreover, the higher corrosion resistance of stainless steel eliminates the painting cost completely. As a result, we have finally started replacing conventional materials with stainless steels. Furthermore, the lightweight design of structures using ASDSS can reduce initial cost by simplifying the lower sections of concrete structures and open/close devices.



*Flood gate.
Picture courtesy of NSSC.*



*Water intake of a dam.
Picture courtesy of NSSC.*



*Water intake of a dam.
Picture courtesy of NSSC.*

Name of Member:

NIPPON STEEL Stainless Steel Corporation

Manufacturer:

IHI Infrastructure systems, Hitachi Zosen Corporation, HOKOKU KOGYO, Marsima Aqua System Corp., NISHIDA TEKKO Corp., HOKOKU KOGYO, Nitto kasen industries

Location:

All over Japan

Environment:

coastal

Grade and surface:

NSSC2120 (SUS821L1), SUS323L

Quantity:

Appr. 1,000 tons (since 2011)

Infrastructure

Pedestrian and bicycle bridge concept in duplex stainless steel

The company Stål & Rörmontage in Sölvesborg, Sweden, has designed a new pedestrian and bicycle bridge concept with patented & protected design and design solutions. The bridge concept is scalable which makes it easy to vary the design parameters, such as the length, which simplifies the design calculations, optimizes the material thicknesses, reduces the weight and lowers the overall costs, including the transport and installation at site. Aesthetically appealing design features includes 10mm “unbreakable glass” sections for maximum

transparency and light sources integrated in the hand railings on both sides. The bridge is made of duplex stainless steel which is fully recyclable, has a high strength and a relative lean alloying content. The duplex steels have a high corrosion resistance in road environments and also in other infrastructure applications, giving a long design life of 120 years or more while minimizing the future maintenance costs as no painting or hazardous coatings are needed. The bridge concept can of course be made

for marine and industrial environments as well using higher alloyed duplex grades. Also costs for shutting down traffic is minimized, which is crucial in highly populated areas and in cities. With LCC (Life Cycle Cost) in focus, maintenance free duplex stainless steel bridges are a very competitive material for bridges that, else, needs expensive on-site maintenance, such as carbon steel and wood bridges. More information can be found at: srmab.com



Name of Member:

Outokumpu

Manufacturer:

Stål & Rörmontage AB,
Sölvesborg, Sweden

Location:

First bridge installed February 2018 over E4 in Södertälje, south of Stockholm, Sweden

Environment:

marine, urban, rural, coastal, industrial

Grade and surface:

Lean Duplex Forta LDX 2404 in the sides and Forta DX 2205 for the load bearing parts. Surface was mill finish 1D.

Pictures courtesy of Outokumpu

Infrastructure

Wynyard Walk

Wynyard Walk is a major pedestrian walkway connecting Wynyard Train Station to the bustling Barangaroo waterfront precinct and Sydney CBD. Completed in 2017, the new infrastructure forms one of several solutions to break pedestrian congestion, with an estimated 75,000 commuters using the hub every day. It features over 1600 m² of perforated and solid stainless steel sheeting into ceiling and fascia panelling installed at the Clarence Street entry façade and the tunnel lining. The panels twist and curve with the bends of the tunnel, creating a sense of flow and motion. Unique to this stunning architectural application is the use of ferritic stainless steel, 445M2, rather than the conventional specification of 304 or 316. The key factors of formability, cost and corrosion resistance, as well as stainless steel's aesthetic appeal were the driving factors around the specification of this grade for this project. This application showcases strong innovation in stainless steel and opens the market to more opportunities. It is a good and different example



to promote the material use (cost savings and life-cycle) in architectural and infrastructure applications, and stainless steel as a whole. Another point of difference (in relation to drafting) was that the project was modelled from point clouds. These point clouds were generated using 3D surveying equipment and modelled to create a real world model in which the stainless steel panels were then generated to suit. This included



the sub structure. This meant there were next to no discrepancies in panel sizes on site and allowed installation to go smoothly.

Pictures courtesy of Stoddart



Name of Member:
Australian Stainless Steel Development Association (ASSDA)
Manufacturer:
Stoddart
Location:
Sydney, Australia
Environment:
urban
Grade and surface:
445M2 grade stainless steel. 2B finish (Although not in a traditional sense. The surface had a slight grain to it).

Infrastructure

Waterfront, Shell Cove

This is an excellent example and opportunity to promote stainless steel in applications requiring the use of rebar (material substitution), as well as reduce the perception that stainless steel is more expensive.

This example says it all – the initial design was for carbon steel, larger concrete cover causing higher costs and slower construction, plus the ongoing requirement for maintenance and servicing for the active cathodic protection. The additional cost is negated by choosing stainless steel and, even with a lighter structure, because of the lower cover, stainless steel is able to provide a longer, durable and trouble-free life.

The original project specification was for alternative materials and products with cathodic protection and sacrificial anodes that struggled to exceed a 50-year life-cycle guarantee. This specification was superseded by a requirement for a 100-year life span, and the use of stainless steel provided the best solution, as well as substantial cost savings around constructability and man hours per tonne required.



Stainless steel rebar offers structural longevity in many environments with exceptional corrosion resistance in harsh marine developments. Its specification in this landmark waterfront development meets the expected 100-year life and was also critical to minimising ongoing costs. This was an important consideration to avoid future maintenance closures due to corrosion issues and to ensure continued public accessibility to



Pictures courtesy of Valbruna Australia

the waterfront promenade for all residents and tourists.

In addition, the use of stainless steel rebar significantly reduced the amount of concrete cover required, also minimising costs and resulting in a more lightweight and higher tensile strength structure.



Name of Member:

ASSDA

Manufacturer:

Valbruna Australia

Environment:

marine, coastal

Grade and surface:

grade 2304 lean duplex stainless steel reinforcement bar ranging from 8 mm to 25 mm

Infrastructure

NS Cover Plate

NS Cover Plate, with highly durable and painted stainless steel used for the exterior, serves both as a permanent cover and scaffolding for such structures as elevated bridges.

The Cover Plates protect highway and railway bridges as well as those built over the sea from such deteriorating factors as wind and rain, sunlight and salt, contributing to extending the lives of these structures. In addition, the Cover Plates work as permanent scaffoldings to enable visual inspections from close distance and ensure safety.

Stainless steel was used as the material is expected to last 100 years and will greatly contribute to extending the lives of infrastructures, which is a social need, and to facilitating maintenance.

The adoption of SUS430J1L, a ferritic grade, has enabled the parties concerned (1) to attain sufficient corrosion resistance, (2) to attain linear expansion ratio similar to that of carbon steel and (3) to enjoy stable costs. Furthermore, fluorine resin painting is deemed to further enhance the durability of the Covers and to harmonize them with the surrounding landscapes where necessary.



Picture courtesy of Japan Stainless Steel Association



Name of Member:
JSSA

Manufacturer:
NIPPON STEEL &
SUMIKIN
ENGINEERING CO., LTD.

Location:
Kawaguchi city, Japan

Grade and surface:
SUS430J1L (painted
with fluorine resin)

Infrastructure

Stainless steel band for fixing pipes

Hot-dip coated steel was conventionally used for the band to fix the life-line pipes laid in the common ditch, which had some problems including the product's susceptibility to deterioration due to corrosion and incurrence of maintenance costs. Thus, the parties concerned introduced maintenance-free SUS304 stainless steel bands. These are in line with the "product-life extension initiatives" promoted by the national government. First, stainless steel coils of optimal thicknesses and widths were picked, then slit and processed in order to minimize material losses. The parties were also able to compensate for the dimensional defects of the base (concrete) with the dimension of the band, thus meeting requirements of the onsite workers and achieving short-time delivery. In addition, unnecessary onsite costs (including labor costs to adjust dimensions through the use of spacer and related materials costs) were saved and with burdens on workers lessened, the project is in progress as planned. The main feature of the stainless steel bands is a drastic overall cost reduction through lowered maintenance costs in the coming years and increased worker productivity.

In the future, construction of common ditches extending approximately 240 km is planned nationwide and demand for SUS304 products is likely to rise, enabling the parties to make further social contribution.



Picture courtesy of Japan Stainless Steel Association



Name of Member:

JSSA

Manufacturer:

Comax Inc.

Location:

Japan

Grade and surface:

SUS304

Infrastructure

Stainless steel supplies for pigpens

A shift of materials from coated products to stainless steel counterparts for livestock barns and auxiliary facilities (particularly pigpens) is progressing at a rapid pace and examples are shown in the pictures. For pigpens where large volumes of ammonia component are generated, coated products only last three to four years. While they are lower than stainless steel in initial costs, a favorable review of the latter in terms of life cycle

costing is now made with expenses associated with replacement parts and installation taken into account.

Besides, such different types of stainless steel as SUS430 and SUS304 have been selected depending on where they are used; components including clasps for partitions, flat bars to support floor grates, angles, etc. For components where strength is required, N2120, a duplex stainless with high

strength, which can be supplied in lighter gauges and made cost-competitive, has also been adopted. As of 2017, there are approximately 4,800 pigpens in Japan and the use of stainless steel in the examples shown here is likely to be a precursor for larger stainless steel consumption in this area and horizontal expansion into such other livestock barn markets as cattle sheds is expected as well.

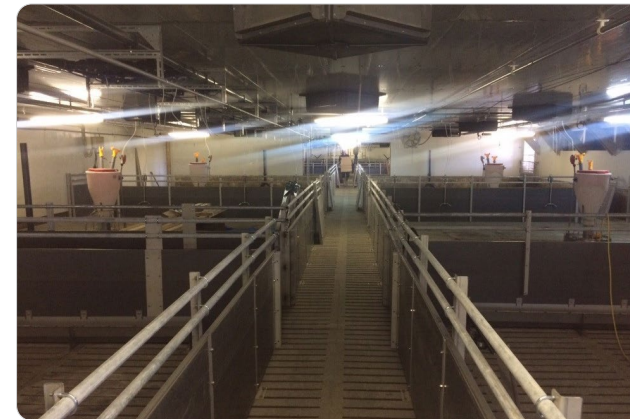

Pictures courtesy of Japan Stainless Steel Association



Name of Member:

JSSA

Manufacturer:

Comax Inc.

Location:

Japan

Grade and surface:

SUS304, SUS430 and
N2120

Infrastructure

Extension of Monaco to the sea

In July 2018, began the transfer of the first concrete caisson reinforced with stainless steel rebars, which was towed from its construction site, in the maritime port of Marseille, and finally installed on its site, for the offshore extension of Anse du portier, in Monaco. This was the first of 18 huge concrete caissons, which with a length of 30 m, 24 m in height, and a unit weight of 10,000 tons, will form the barrier of protection against the sea for the new extension of 6.5 hectares of the new district of the city, which will lead to the construction of 60,000 m² of new luxury homes, shops, a park and other public facilities.

The important maritime infrastructure project is developed by the prestigious French construction company Bouygues Travaux publics. The current phases of the Project, corresponding to the submerged infrastructures, will take place until 2020, and then the construction of buildings will proceed until 2025.

For the construction of the stainless

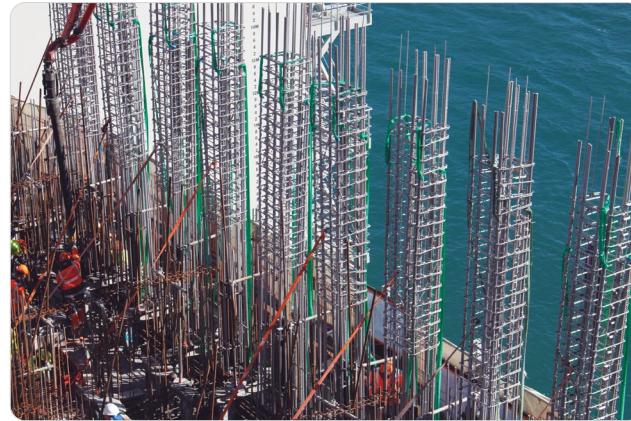

reinforcements, manufactured by the French-Spanish company Sendin and assembled in Marseille by their own workers, more than 4000 tons of stainless steel rebars, RDN 915-EN 1.4362 AISI 32304 duplex type, have been used, with diameters between 12 and 40 mm, supplied by the company Roldan S.A. , belonging to the Acerinox group, from its Ponferrada (León) plant in Spain.



Pictures courtesy of Bouygues

This type of stainless steel with high resistance to corrosion against sea water chlorides, which eventually will penetrate the concrete by capillarity reaching the reinforcements, will provide long durability of these infrastructures, without presenting deterioration due to problems of corrosion, avoiding costly maintenance costs in the future.



Name of member:

Acerinox

Manufacturer:

Roldan-Acerinox Group

Location:

Monaco

Environment:

marine, coastal

Grade and surface:

duplex stainless steel rebar EN 1.4362

Competing materials:

carbon steel rebar, epoxy, galvanized steel

Infrastructure

Stainless steel highway sound barriers

Most of the Highway sound barriers installed in the U.S. are made out of carbon steel or galvanized steel. These barriers undergo a constant process of replacement and maintenance due to the corrosion resulting from the extensive use of road salt during the winter season as well as the humid conditions prevalent in coastal areas.

Companies such as "Empire Acoustical Systems" out of Princeton, IL offer the solution by producing barriers made from stainless steel. The outer shells of the panels are made with corrosion resistant NAST304 grade in thickness ranging from 0.8 mm to 1.5 mm. The soundproofing core is made with high density mineral wool, the level of sound absorption is extraordinary with levels of NCR of 1.0 and STC of 34 measured per requirements of norm ASTM C423 and ASTM E90.

The panel's size are 12" x 12" and are installed in parallel to make up the sound barrier. The panels are painted to the specifications of the customer, including in some cases where they were painted to mimic the look of wood or other non-metallic elements.



Pictures courtesy of Empire Acoustical Systems



Name of member:

North American
Stainless

Manufacturer:
Empire Acoustical
Systems

Environment:
urban

Grade and surface:
T304 2D

Competing materials:
carbon steel and
galvanized steel

Infrastructure



Brescia metro stations

The Brescia metro was designed to connect the northern districts of the city with those of the southeast area, through the centre, and stainless steel has been used in the construction of the various stations. These stations are the result of a project with both functional and aesthetic connotations, envisaged by Brescia Infrastrutture, aimed at unifying their shape, both for the design and for the choice of materials. Stainless steel EN 1.4301 (AISI 304), in the form of 1 mm thick sheets and with various surface finishes, was widely used. For some types of infill walls, composite panels were used which consist of a coupling between an external "skin" of stainless steel sheet (with thicknesses varying from 0.5 to 0.8 mm) and aluminium honeycomb. Using this technique, excellent flatness and a typical stiffness of the composite materials was obtained.

Pictures courtesy of Centro Inox



Name of member:

Centro Inox

Manufacturer:

Steel Color S.p.A. – via
per Pieve Terzagni 15 –
I-26033 Pescarolo ed
Uniti – Cremona – Italy
Tel. +39.0372.834311
info@steelcolor.it,
steelcolor.it

Location:

Brescia, Italy

Environment:

urban, indoor

Grade and surface:

EN 1.4301 (AISI 304),
various surface finishes

Infrastructure

First use of duplex stainless steel Forta LDX 2404, UNS S82441 in a major bridge building project

Forta LDX 2404, a new duplex stainless steel from Outokumpu, standardised as grade EN 1.4662 and UNS S82441 has been selected for its first major structural project, the Söderström rail bridges in Stockholm.

The Söderström network comprises four bridges carrying metro trains, each approximately 174 m in length between the districts of Slussen and the Old Town in Stockholm. The bridges were originally built in 1957 with their superstructure constructed from welded carbon steel. The tracks are intensively used, carrying 340,000 people per day by metro with an average of one train every three minutes.

An assessment carried out in 2013 by the Swedish traffic authority, Trafikverket, concluded that due to extensive corrosion attack required the old carbon steel superstructure to be replaced. With a Pitting Resistance Equivalent, PRE of approximately 33,

Forta LDX 2404 fills a gap between standard duplex grades UNS S32304 and UNS S32205. In addition, it has higher strength than these standard duplex grades, making it particularly suitable for structural applications. A comparison of a replacement structure constructed from painted carbon steel to a structure in Forta LDX 2404 duplex stainless steel was undertaken by Swedish engineering consulting firm Bostek. This study concluded that the low maintenance requirement of Forta LDX 2404 duplex

stainless steel gave a significant reduction in the 120 year whole life costs, despite higher initial costs compared to carbon steel.

Outokumpu has supplied 600 tonnes of plate material. This project represents a significant advancement, as it demonstrates that Forta LDX 2404 duplex stainless steel can be used in a major bridge engineering project on the basis of Life Cycle Cost and other whole life benefits.

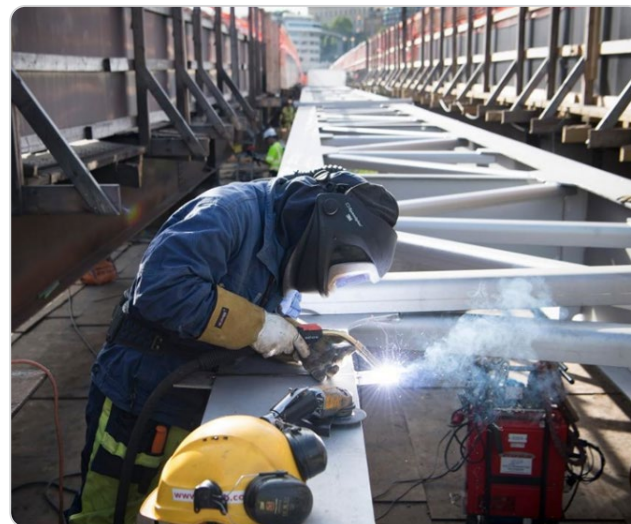

Pictures courtesy of Stål & Rörmontage



Name of member:

Outokumpu Oyj

Location:

Stockholm, Sweden

Environment:

coastal

Grade and surface:

Forta LDX 2404,
EN 1.4662, UNS S82441,
1D & 2E

Competing material:

carbon steel

Infrastructure

The sediment discharging facility at the Biratori Dam

Biratori Dam in Hokkaido is under construction to reduce the flood damage in the downstream area at the time of heavy rain, by storing part of the flowing water with Nibutani Dam which is already constructed. Because Biratori Dam is located in



one of the heaviest snowfall areas in Japan and the river flows through the bottom of valleys with sheer cliffs, it has been a problem that the sediment abraded by snowslides gets into the river and is piled up in the reservoir.



In order to solve this problem, it was decided to install a sediment discharging facility at the bottom of the dam body. This is the third case in Japan to install such a facility, following Dashidaira Dam and Unazuki Dam. The facility consists of a sand discharging pipeline made of concrete, and high-pressure gates which are made of SUS304. In addition, it is expected that hard stones which will be piled up at the bottom of the dam will abrade the inner surface of the concrete pipeline; therefore duplex stainless steel NSSC2120, which has high strength and hardness, was applied as lining to protect from abrasion. Approximately 200 tons of NSSC2120 was used, including bolts made of the same grade to attach the lining to the pipeline. Since it could be said that climate change leads to more frequent heavy rain, a lot of dams for flood control are planned to be constructed in Japan, and these technologies have gathered attention from several countries which are facing similar problems.

Pictures courtesy of NSSC



Name of member:
NIPPON STEEL
Stainless Steel
Corporation
Manufacturer:
Marsima Aqua System
Corp.
Location:
Biratori-cho, Hokkaido
Environment:
rural
Grade and surface:
NSSC2120, 200 tons;
SUS304, 350 tons

Infrastructure

The lock gates of Miyako city ferry terminal

The Sanriku coastal area of Tohoku region has experienced several tsunami disasters as it faces the Pacific Ocean, and a large-scale seawall is now under construction. Lock gates are the gates which are installed at several places of a seawall where people and vehicles can get through.

Miyako City, located in the Sanriku district, experienced a tsunami which exceeded 10 meter-high in the Great East Japan Earthquake in 2011. After the disaster, a 9 meter-high seawall was constructed and twenty lock gates of the same height were planned to be installed; originally those would be manufactured with aluminium alloy. The larger lock gates must be strong enough against water pressure. The largest lock gate is 9.2 meter-high and it is required to apply extremely thick aluminium alloy plate to withstand

increased water pressure. Therefore, duplex stainless steel which has high strength was finally adopted. Duplex stainless steel, which is about 3 times stronger than aluminium alloy, allowed to reduce not only the weight but also the construction cost. Moreover, SUS821L1, whose specific strength is superior to aluminium alloy, enabled to reduce the girder height as it is not necessary to care deflection, and the appearance of lock gates became more stylish. Approximately 250 tons of stainless steel plates were applied to two large lock gates, and it should be noted that this application created demand of stainless steel in the lock gate market which has long been dominated by aluminium alloys.

Pictures courtesy of NSSC

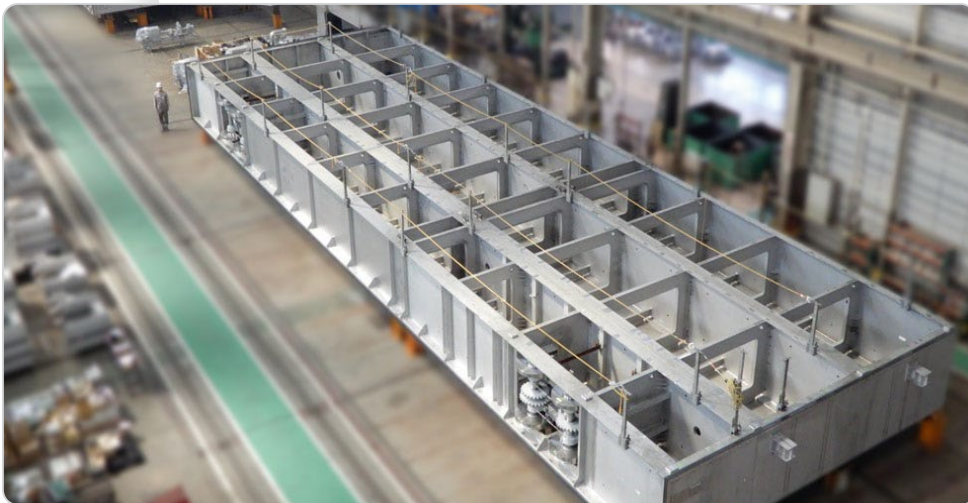

Name of member:
NIPPON STEEL
Stainless Steel
Corporation

Manufacturer:
Marsima Aqua System
Corp. , Chuoh Co.

Location:
Miyako-city, Japan

Environment:
rural, coastal

Grade and surface:
SUS821L1 250 tons

Competing material:
aluminium alloy

Infrastructure

Façade of interior pedestrian hall at Mexico City International Airport

The façade contributes because it is an original application in two ways:

- Transform a stainless steel sheet into a unique corrugated shape with a surface finish on both sides
- The stainless allows to place an element of 350 meters length that seems flat.

Mexico City International Airport has a large number of users, more than 44 million of passengers during 2018, so this highly exposed application is a very effective way to promote the material.



Pictures courtesy of Ullises Silva Cruz



Name of member:
IMINOX

Manufacturer:
Obras de Arte, Inventos, Sueños

Environment:
indoor

Grade and surface:
304 with interior and exterior polished finish

Competing materials:
glass, carbon steel, aluminium

Infrastructure



Municipal water storage tanks manufactured in 3CR12 instead of concrete

Sky Hill Heavy Engineering specified 3CR12 to be used for Municipal water storage tanks rather than concrete tanks in rural areas. The innovative design, using an inverted bottom cone, allows drainage of sludge and cleaning without emptying the tanks. Sky Hill specified 3CR12, designed the innovative tank and fabricated these tanks. 3CR12 is the ideal material of choice in ambient temperature water applications where there are no stagnant conditions and crevice conditions are avoided, such as prolonged sludge build-up. Sky Hill has promoted stainless steel by convincing the provincial government to accept 3CR12 rather than the traditional concrete tanks. Sky Hill Heavy



Engineering also recognised the need for an easy and efficient method of removing sludge without the need to empty the tank. The innovative design has allowed 3CR12 to be used with confidence in this application.



Name of Member:
SASSDA
Manufacturer:
Sky Hill Heavy
Engineering
Location:
South Africa
Environment:
outdoor
Grade and surface:
3CR12 No. 1

Infrastructure

Application development of stainless steel in reservoir

Analysis of the Korean water reservoir industry has shown that the main issue of material application in this field is hygiene and enlargement. In the case of a conventional concrete reservoir, maintenance requirements, due to surface degradation such as blisters and defects upon aging must be treated regularly from a hygiene standpoint. Whereas, stainless steel is insensitive for this issue. Due to a rapid increase of the urban area population, large-scale water consumption regions have steadily been increased. Here, the structure must be strong enough to meet the safety requirements upon

natural disasters such as snowfall, earthquakes and typhoons. In this sense, high strength stainless steels with excellent corrosion resistance can be a good candidate material for light-weight and life-cycle-cost. Lean and standard duplex stainless steels have finally been designated as suitable materials. The current example demonstrates how the demo project is pushed forward in this field from the viewpoint of hygiene and enlargement. The targeted tank structure has been designed with circular-shape reaching its volume up to 3,000~20,000 m³. In line with its massive scale and endurance requirement, POSCO promoted high strength corrosion resistant duplex in diverse

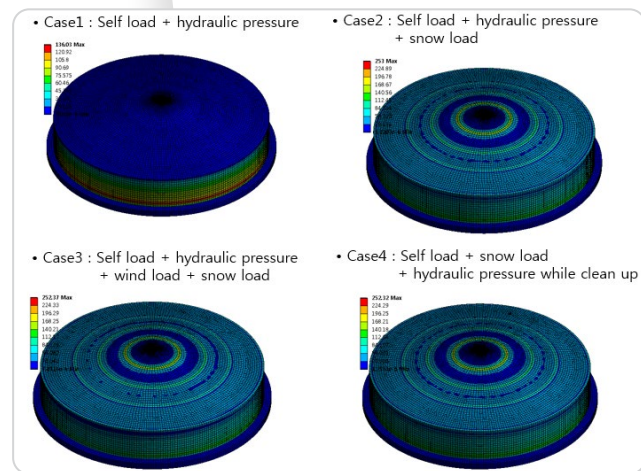

Total stress analysis. Picture courtesy of POSCO

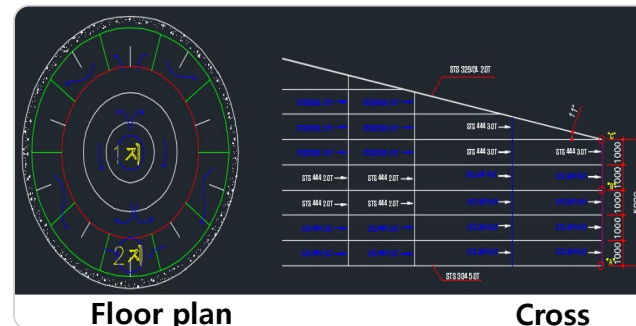

Structure map. Picture courtesy of POSCO



Reservoir in Changwon. Picture courtesy of POSCO



Name of Member:
POSCO

Manufacturer:
Geum Kang

Location:
Changwon, South Korea

Environment:
outdoor

Grade and surface:
STS304, STS444,
STS329J3L / 1D, 2B

Quantity:
160 tons

ways; products briefing such as either to the municipal cooperation, water tank vendors and construction companies.



Reservoirs in Naju. Picture courtesy of POSCO

Infrastructure

Water supply tank in Yonago

Duplex stainless steel SUS329J4L is used for the new water supply tanks built by the Bureau of Yonago City Waterworks in Tottori, Japan. The Central Water Supply Tank which is one of the new tanks, is one of the largest cuboid type stainless steel water supply tanks in the world, whose capacity is 16,000 m³. High corrosion resistance to withstand a severely corrosive environment was indispensable for the material of both the inner and outer surfaces of the tanks. They were installed on the top of a mountain near the coast of the Japan Sea and will be exposed to strong seasonal sea breezes, while the water



Picture courtesy of NSSC

stored in the tanks contains sodium hypochlorite as a disinfectant. Moreover, high strength was required for the material to resist pressure from the large quantities of water stored in the tanks. Furthermore, a pleasing aesthetic appearance was required on the outer surface of the tanks, as symbols of this area.

The duplex stainless steel is the best solution in order to meet all these requirements. The material also enabled to reduce cost as painting and coating are not necessary.

Stainless steel is superior to other materials for water supply tanks, as it has excellent earthquake-proof and water-tightness. Tanks made of stainless steel can also be installed in a shorter period of time compared to concrete-made tanks.

As demands for renewal of deteriorated concrete-made water supply tanks built around the 1970s are increasing, it is expected that demands for stainless steel in this application also will grow.



Name of Member:
NIPPON STEEL
Stainless Steel
Corporation
Manufacturer:
Morimatsu Industry Co.
Ltd.
Location:
Yonago City, Japan
Environment:
outdoor
Grade and surface:
SUS329J4L/N^o4,
SUS304/N^o1,N^o2B,
SUS316/N^o1,N^o2B

Infrastructure

Stainless steel lined water reservoir

From about 20 years ago most water purification plants and reservoirs in South Korea were built with concrete. The concrete deteriorated over time with age and contaminates purified water due to chemical substances which caused cracks on the surface. To prevent these problems, crack treatment and epoxy waterproof coatings have been applied to the surface of concrete as a countermeasure. However, these applications only have temporary effect and need to be re-coated every 4 to 5 years, which leads to an increase in maintenance cost. Therefore a semi-permanent solution such as a PE or stainless steel lining is required.

The advantages of stainless steel lining are as following. First, stainless steel is known as the best material for the water environment to preserve water quality. Secondly, the maintenance cost can be reduced because repairs of concrete surface and epoxy coating are unnecessary. Finally, since stainless steel is superior in suppressing microbial generations to concrete or PE, microbial corrosion and water contamination can be prevented.

The stainless steel lining material is duplex such as STS329LD, STS329J3L which has excellent resistance to the corrosive atmosphere of chlorine environment. The major technologies for the stainless steel lining construction are welding and anchoring to connect concrete and stainless steel. POSCO has reviewed and verified various factors with customers to offer the optimal lining technique and working with customers to develop structures that reflect seismic design standards in case of earthquakes.

As the existing structures continue to age naturally, the demand of stainless steel lining is expected to increase gradually.

BEFORE



AFTER



Name of Member:

POSCO

Manufacturer:

Moonchang Co., Ltd.

Location:

Gangneung City, Korea

Environment:

urban, rural, industrial,
indoor

Grade and surface:

STS329LD, STS329J3L /
2B

Pictures courtesy of POSCO

Infrastructure

Metal support for ventilation duct used in the work on ventilation equipment for the underground flood control reservoir in the Furukawa river (no. 1)

In a project to upgrade the infrastructures of Tokyo to deal with localized torrential rain allegedly caused by the climate change in recent years, stainless steel (SUS304) was selected for the metal support of the ventilation duct. With this adoption, it is anticipated that stainless steel will make a greater social contribution in infrastructure improvement works.

Tokyo's decision to use stainless steel for such an application is likely to help



Name of Member:

JSSA

Manufacturer:

EBARA JITSUGYO CO.,
LTD., AICHI STEEL
CORPORATION

Location:

Tokyo, Japan

Grade and surface:

SUS304

prompt other local governments to follow the suit and lead to increased use of stainless steel thanks to its advantages in corrosion resistance and life cycle cost.

Picture courtesy of the Japan Stainless Steel Association

Infrastructure

Innovative modular concept for wastewater treatment tanks

Invest-Tech, a Polish company specializing in planning and building wastewater treatment plants, has developed an innovative, modular concept for wastewater tanks that makes them much more flexible for expansion. These tanks are built out of separate stainless steel segments in a square or rectangular shape so that they can be flexibly extended whenever necessary. Additional flexibility is given as the segments are bolted together and not welded.

The major design challenge for the tanks is the water pressure. A tank with dimensions 23 x 11 x 6 meters (Length x Width x Height), containing 1,200 cubic meters water has to withstand a pressure of approximately 0.6 bar in a straight



Pictures courtesy of INVEST-TECH



wall of 23 meters with a deflection of maximum 10 mm only. Outokumpu Forta LDX 2101 duplex stainless steel offers the necessary strength as well as corrosion resistance and good weldability – as there are still some elements that require welding.

The first wastewater treatment plant using Invest-Tech's new tank design, constructed from around 120 tons of Forta LDX 2101 is now in operation in Poland. Invest-Tech is planning to promote its design in other EU countries as the perfect solution for smaller villages that might need to extend their wastewater treatment capacities in the future.

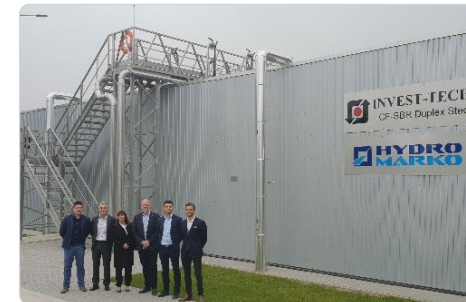
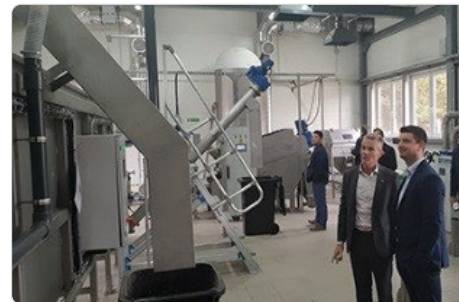

Name of member:

Outokumpu Oyj

Manufacturer:

Invest Tech

Environment:

urban

Grade and surface:

Forta LDX 2101

Infrastructure

C 2 Fresh Water

C 2 Fresh Water, (patent pending), is an invention that can clean polluted or sea water to a safe potable water without using any filters. It can be used for irrigation purposes, depending on the segments installed in tandem or the quantity of units. The unique way of separating the fresh water is one of the outstanding features. We condense the steam which will be fresh water. This water will be ozonated to ensure that no bacteria can be present in the water. Segments can be added to improve the production to as much as 40 segments



per unit which will result in a total length of 100 metres. The solar system will follow the sun by means of an electronic unit. The idea of this invention is to be used without the use of fossil based fuel or any outside energy source, and solely depends on solar energy. In the case of seawater it can produce salt as a by-product. For polluted water, one can recover minerals and trace elements on the waste side. It is much more cost effective compared to reverse osmosis systems. This product poses absolute no danger to birds or the environment in comparison with solar farms. Although the plumbing is part of the unit, it does not rotate with the rest of the equipment, which makes this unit unique on its own, with less moving parts. This unit can also be used for fish farms in the process of heating water to the required temperatures.

Pictures courtesy of Columbus Stainless



Name of member:
Columbus Stainless
Manufacturer:
Destrilix PTY (LTD) –
Jaco Prinsloo
Environment:
marine, urban, rural,
coastal, industrial
Grade and surface:
austenitic and ferritic
stainless steel

Domestic appliances

Black Stainless steel for premium appliances

Over the past decade, stainless steel has been widely used for high-end appliances due to its elegant surface and durability. Despite the wide usage of stainless steel, there were consumer's needs of both functional and aesthetic aspect. Traditional stainless steel requires constant maintenance and cleaning due to fingerprints. Black stainless steel, on the other hand, is easy to care because it is smudge-proof. Also by adding dark-tint to coating liquid, it became to have better look on the surface.

Black stainless is a type of anti-finger coated steel with black nano powder added. It requires high quality control from base material to coating process. The base material has to have a clean surface free of any defect, because it affects the quality of polished steel, and coated steel at the end. The most important control factor is a color match. Keeping color consistent by managing manufacturing conditions (curing temperature, thickness of coating, and liquid composition) require sophisticated and complex technical skills.

There had been trend transition from white goods to stainless steel in the past decades. Black Stainless created the new trend in premium segment and it has moved stainless steel category to an exclusive high-end market. Starting from LG and Samsung, major home appliances companies including GE, Frigidaire, KitchenAid, and Whirlpool have begun to manufacture a full line of Black Steel. It now accounts for 30% of package sales.

By going through the successful experience in the home appliances market, we found a high potential in black stainless steel. To extend the market, we've been approaching other industries such as art, furniture, architecture and building. Since each usage has different key quality requirements, we developed a suitable coating system and manufacturing process. In the near future, black stainless would settle down as one of alternative material to satisfy consumer's unlimited desire.



Pictures courtesy of POSCO



Name of member:
POSCO

Manufacturer:
LG, Samsung
Electronics, Electrolux

Environment:
indoor

Grade and surface:
ASTM430 Black
Anti-finger Coated

Domestic appliances

Development of PossFD for refrigerant piping

Copper is one of the most consumed metals in the airconditioning industry, however, the price of copper is relatively higher than other competitive metals and has sharply increased recently. Copper tubes have also been used for refrigerant piping between components of air conditioning systems for its excellent formability. With the interest to reduce the manufacturing cost by replacing copper with other materials, the development of soft stainless steel was initiated.

Stainless steel may not be able to be as soft as copper, however, very soft austenitic stainless steel, PossFD has been developed with excellent

flexibility and

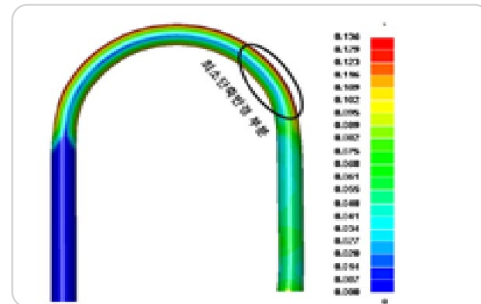

drawability. Copper tubes are so flexible to bend that an elbow or U-bend are easily formable. Several bending tests with pipes made of PossFD have been performed to evaluate its formability and deduce the optimized thickness for each pipe with a different diameter. PossFD has equivalent corrosion resistance compared to copper and PossFD tubes have a better performance under pressure test compared with copper tubes due to its higher strength. After optimizing the manufacturing process for PossFD in the factory, where only copper has been processed in advance, PossFD tubes were finally approved for refrigerant piping at several major airconditioner models to replace copper tubes.

PossFD for air conditioning systems can be a good example to create a new market for stainless steel by replacing competitive materials. Furthermore corrosion resistance is still the dominant characteristic of stainless steel therefore higher chromium stainless



Pictures courtesy of POSCO

steel may be considered for some parts of air conditioning systems under severe conditions. Along with the innovation of home appliances, stainless steel will also develop new grades and create more applications.

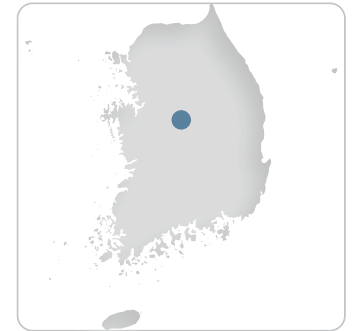

Name of Member:

POSCO

Manufacturer:

LG Electronics

Location:

South Korea

Environment:

urban, rural, industrial, indoor

Grade and surface:

PossFD, No.2D

Domestic appliances

Stainless steel for Hard Disk Drive (HDD) cover

Hoshin Kenzi supplies stainless steel grade SUS 304, SUS 430 and SUS 420 to Western Digital, Seagate and Toshiba for manufacturing of the Covers and other Components parts for Mechanical Hard Disk Drives (HDDs).

- 3 Main Global Keys HDD manufacturers are Seagate, Western Digital and Toshiba
- In the recent years, "Clouds Storage" have become inevitable; and Data Storage Centres are expanding and being built in different parts of the world, the quest of Higher Capacity of HDD Storage has instigated for new challenges to Data Storage technology.
- HDD Storage of usual less than 8TB has tremendously grown to the present increase in demand of 10TB, and working towards next level of 15-16TB.
- Stainless steel with superior characteristics over other metals and materials, it is the best material to use to form Covers for the HDDs and other precision parts of the mechanism for the HDDs.



Picture courtesy of Hoshin Kenzi



Name of member:
Bahru Stainless

Manufacturer:
HOSHIN KENZI(S) PTE LTD

Environment:
indoor

Grade and surface:
SUS304, SUS430,
SUS420

Competing materials:
aluminium, plastic

Domestic appliances

A box for home delivery

Since many kinds of goods are delivered to homes through the internet and other vendors, situations in which the customer is not at home have increased recently. This causes many missed deliveries and is a huge problem for customers and companies. To solve this problem, boxes for home delivery have been introduced.

Since boxes for home delivery are placed in outdoor environments, an attractive appearance and corrosion resistance are required. SUS443J1 with high corrosion resistance provides good formability and a suitable surface finish for painting. Therefore we expect that boxes for home delivery made with this kind of stainless steel will increase.



Picture courtesy of NASTA Co., Ltd.



Name of member:
JFE Steel Corporation
Manufacturer:
NASTA Co., Ltd.
Location:
Japan
Environment:
urban, rural, coastal
Grade and surface:
SUS443J1 2D (KD)
Competing materials:
304, coated steel

Automotive

Transportation container in high-chromium Austenitic 316plus

Finnish Lanh Group Cargo Solutions has chosen Outokumpu's new highchromium austenitic steel grade Outokumpu 316plus™ (Outokumpu 4420) in cold worked condition for their special transportation containers. The container's floor and walls are made of Outokumpu stainless steel due to strict requirement for wear and corrosion resistance. 316plus enables transportation of aggressive and sharp bulk materials. The properties of 316plus allow thinner wall thickness resulting in lower overall weight of the container. Outokumpu 316plus is a unique product developed by Outokumpu that provides a competitive alternative for 316(L). 316plus contains less nickel and molybdenum and the grade has higher strength than 316(L) even in annealed condition due to higher nitrogen alloying. This summary was quoted from the article from "Outokumpu".



Picture courtesy of Outokumpu Oyj



Name of member:

Outokumpu

Manufacturer:

Lanh Group Cargo Solutions

Location:

Finland

Environment:

outdoor

Grade and surface:

Outokumpu 316plus
(Outokumpu 4420)

Automotive

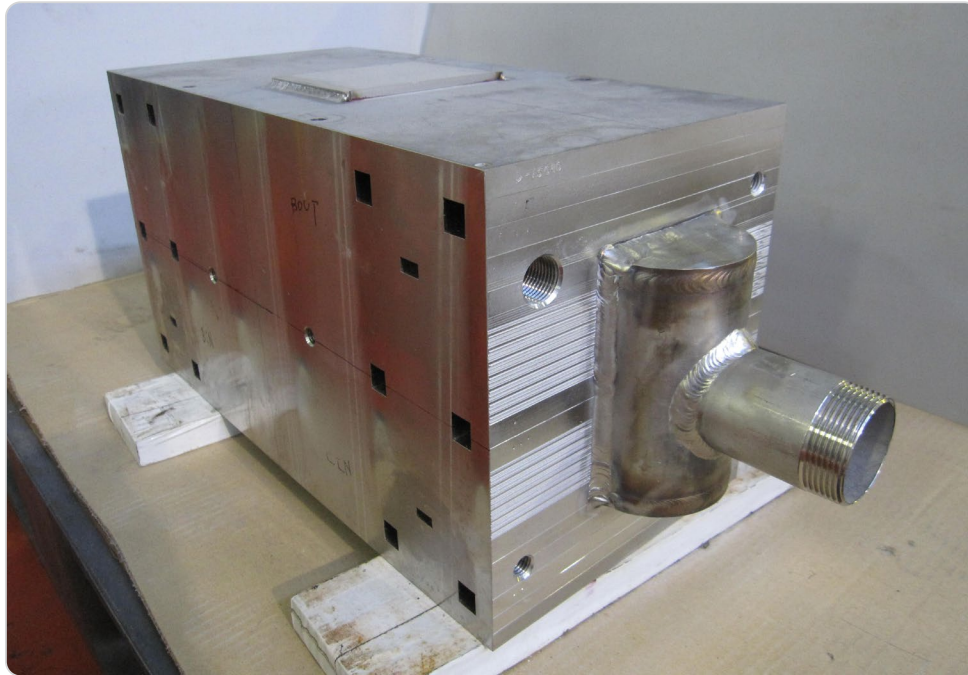

Picture courtesy of Japan Stainless Steel Association

Diffusion bonded compact heat exchanger made of austenitic stainless steel

DCHE (Diffusion Bonded Compact Heat Exchanger) is a compact heat exchanger with excellent heat transfer performance and high pressure resistance. One of the applications is a hydrogen station, which supplies hydrogen gas to FCVs (Fuel Cell Vehicle). DCHE is used for a cooler of the compressor, and for a cooler of the hydrogen dispenser.

One of the important factors is an efficient cooling hydrogen of approximately 80 MPa with water and coolant. The other important factor is compactness because this equipment is installed in the premises of a gasoline station. In addition, this equipment must have a higher resistance against hydrogen embrittlement since this equipment is exposed to high pressure hydrogen. Therefore, a modified type 316L having higher Ni content with excellent hydrogen embrittlement resistance is selected as a material. DCHE has created new demand for stainless steel and is considered to be a device contributing to hydrogen society.



Name of Member:
Nippon Yakin Kogyo
Manufacturer:
Kobe Steel Ltd.
Location:
Japan
Environment:
indoor/outdoor
Grade and surface:
modified type 316L
Quantity:
150 kg per unit

Automotive

Non-coated stainless steel bipolar plate for hydrogen fuel cell vehicle

Fuel-cell vehicles are attracting attention as the ultimate eco-friendly car as they solve the problem of mileage and charging time, which are the shortcomings of electric cars. Through joint development with Hyundai Motor (2013~2017), POSCO has created a new market for stainless steel in the fuel cell vehicle sector by developing a non-coated super-ferritic stainless steel, Poss470FC, for the bipolar plates of fuel cell stack.

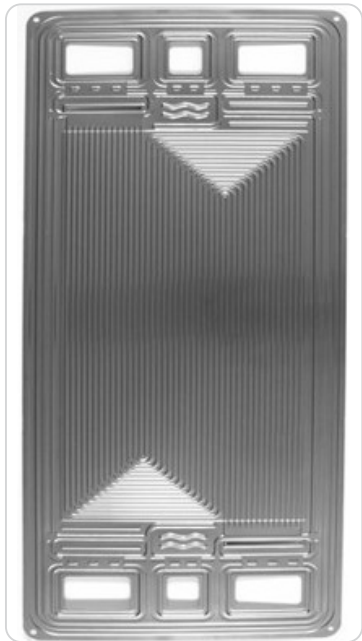

Pictures courtesy of POSCO and Hyundai Motors



The material used for bipolar plates should be excellent in corrosion resistance and electrical conductivity. The developed Poss470FC stainless steel has an alloy design that ensures excellent corrosion resistance and world-top electrical conductivity without any additional coating process. As to the superior conductivity, instead of a complex and expensive coating process, a relatively simplified chemical reforming procedure could remarkably enhance the surface conductivity of Poss470FC that is equal to or better performance than that of C-coated Ti. With the advent of this competitive bipolar plate, the cost of stack manufacturing has been reduced, contributing to the potential expansion of fuel cell vehicles.

Poss470FC has been commercially applied in Hyundai Motor's fuel cell vehicle, NEXO, which came on the market in March 2018, with world top performance of mileage per charging, 609 km and a charging time of 5 min.



Name of member:
POSCO
Manufacturer:
Hyundai Motors, KOREA
(Model : NEXO)
Environment:
marine, urban, rural,
industrial
Grade and surface:
Poss470FC,
electrochemically
modified surface

Automotive



Hydrogen fueling receptacle in the Toyota MIRAI fuel cell vehicle

Aichi Steel's self-developed AUS316L-H2 has contributed to an Eco-friendly society by the use for hydrogen fueling Receptacle of Toyota MIRAI Fuel Cell Vehicle.

Features: In high-pressure gaseous hydrogen, AUS316L-H2 has excellent mechanical properties such as ductility. Furthermore, AUS316L-H2 can have higher strength by cold drawing process, which enables to realize lighter-weight and lower-cost, keeping its superior ductility.

From now on, AUS316L-H2 will keep on playing important roles not only in the automobile industry but also in hydrogen gas stations, and the hydrogen society.



Name of member:
Aichi Steel Corporation
Manufacturer:
Toyota Motor Corporation
Location:
Japan
Environment:
industrial
Grade and surface:
AUS316L-H2
(equivalent to JIS
SUS316/316L)



Pictures courtesy of Aichi Steel and Toyota Motor Corporation

Automotive

Grommet gasket for innovative diesel engine

To develop a diesel engine with superb fuel efficiency and environmental-friendliness is a must to enhance international competitiveness of the Japanese automotive industry. A new type of diesel engine designed for an innovative car for a global strategy puts higher loads on the gasket than conventional engines, demanding better sealing performance and reliability. With a new gasket structure devised, the required sealing performance was attained but as higher loads were placed on the grommet plate, the annealed stainless steel sheets of conventional grades such as SUS304 and SUS403 cracked. Also, cold rolled stainless steel products with higher strength lacked plasticity and were found unfit for gasket manufacture. Thus, materials with both strength and plasticity were sought. The grades newly developed this time are annealed and as such have an elongation of 40% and are fit for processing. In addition, with crystalized grain miniaturized, they have the enduring force of more than 600 MPa and besides, surface damage in the bending process is reduced and wear resistance is excellent as well. A series of new developments achieved this time have dramatically improved the function of stainless steel gasket, which in turn has helped launch an innovative diesel engine.



Picture courtesy of Japan Stainless Steel Association



Name of Member:

JSSA

Manufacturer:

NIPPON GASKET CO.,
LTD.

Location:

Japan

Grade and surface:

SUS301L Equivalent,
SUS301, etc.

Automotive

Turbine housing (CK-SMiTH)

Automotive exhaust gas regulations in a number of countries of the world have been tightened in recent years. Particularly, regulations on PM and NOx emitted from diesel engines have become more stringent. Under the circumstances, a turbocharger is now an indispensable component because it works not only to maintain horse powers but also to purify exhaust gas and to improve fuel efficiency so that environmental burdens may be reduced.

Capturing this trend, the Calsonic Kansei

Corporation has developed [CK-SMiTH], a new product, through making the turbine housing of a turbocharger with sheet product leading to a weight reduction of the component and to a drastic upgrading of temperature-raising performance of the automotive catalyst. Turbochargers must take in exhaust gas of elevated temperature and have been conventionally made of cast iron for ensuring necessary heat resistance and durability.

To make [CK-SMiTH], heat-resistant ferritic stainless steel sheet, which is difficult to process, is press-formed into a complicated shape and a dual structure of outer pipe and inner pipe is employed. With such ingenuity, [CK-SMiTH] performs better than conventional cast iron turbochargers in terms of heating the automotive catalyst and purification of exhaust gas. Making the component with sheet product also reduces its weight by 15% and contributes to the improvement of fuel efficiency.



Pictures courtesy of Japan Stainless Steel Association



Name of Member:

JSSA

Manufacturer:

Calsonic Kansei
Corporation

Location:

Japan

Grade and surface:

Heat-resistant ferritic
stainless steel

Automotive

MaX: Ultra-High Strength stainless steel for body in white and chassis applications

New technologies, new regulations and new expectations require car manufacturers to think outside the box. As a result, a new generation of vehicles is demanding new material solutions to reduce weight, improve safety, cut emissions and lower costs. To meet this demand, Aperam partnered with market-leading companies to produce MaX – the market's only Advanced High Strength Stainless Steel for body-in-white and chassis applications. As an ultra-high strength steel formed by hot stamping on underfloor panels, MaX has the lightweight performance of aluminum and the cost-effectiveness of carbon

steel. Its simplified production process, which reduces the number of required parts from 19 to just 3, not only cuts investment costs, it reduces weight by up to 15% – all while maintaining the same properties. In terms of fatigue performance, MaX matches baseline measurements for fatigue performance, and even outperforms the baseline for crash resistance.

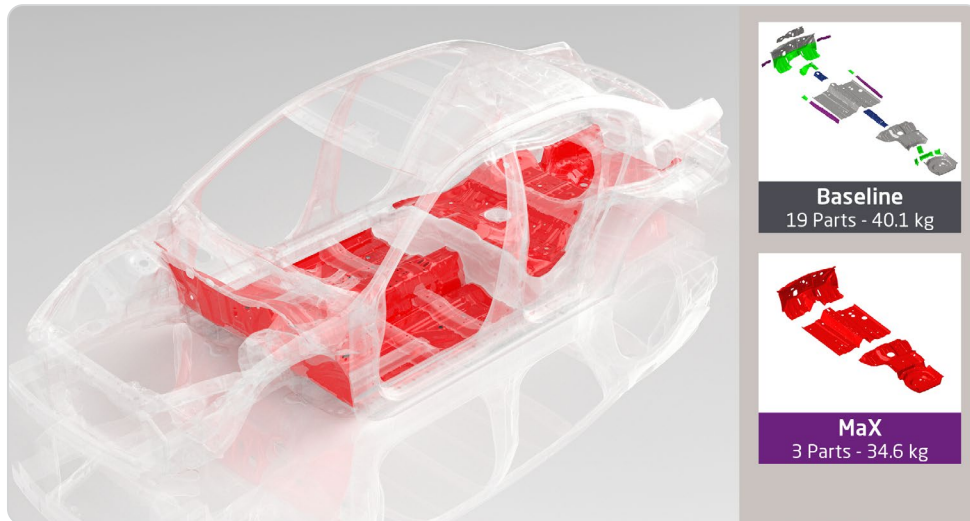

Pictures © Aperam

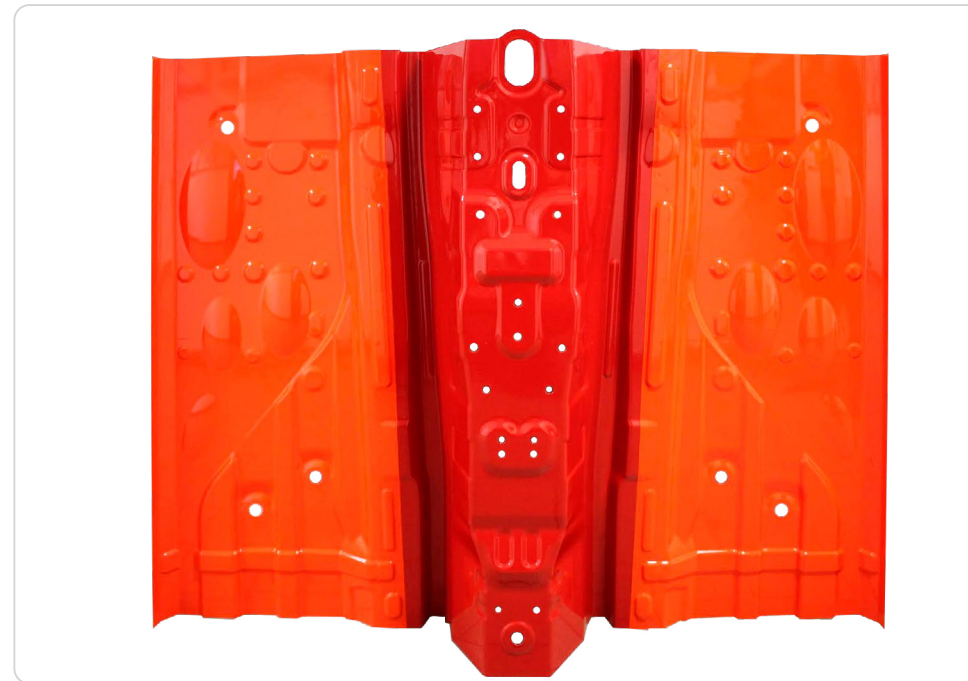

Name of Member:
Aperam
Manufacturer:
Worldwide Automotive
sub-suppliers and Tier 1
Location:
worldwide
Environment:
outdoor
Grade and surface:
MaX from 0.55 to 1.55
depending on the parts

Automotive

Exhaust Gas Recirculation (EGR) Pre-Cooler

In internal combustion engines, exhaust gas recirculation (EGR) is a nitrogen oxide (NOx) emissions reduction technique used in petrol/gasoline, diesel and hybrid engines. It also increases efficiency giving better fuel consumption. An EGR cooler lowers the temperature of exhaust gases recirculated by the EGR and thereby decreases the NOx emissions. Senior Flexonics from Cape Town, South Africa worked in collaboration with Senior Flexonics from Crumlin, Wales to design and develop an EGR cooler product and assembly process. The target market for this cooler is the passenger vehicle and On/Off Highway vehicles.

- **Product:** The cooler is a light weight stainless steel tube-in-tube design with excellent thermal loading characteristics.
- **Design:** The patented design is simple, compact, routable and cost effective to manufacture. It cools recirculating gasses by up to 150°C through a finned tube length of 100 mm.

- **Manufacture:** The cooler is assembled and vacuum brazed in Senior Flexonics Cape Town. It consists of stainless steel and Inconel castings, spigots, bellows, tubes and flanges and is Nickel brazed.

This cooler design cannot be manufactured from any other material at a competitive cost and still maintain its functionality.

In the local market these coolers support the market for thin-gauge stainless steel (from Columbus Stainless (Pty) Ltd), which historically have been used mainly for the manufacture of flexible decouplers. It therefore diversifies the use of thin gauge stainless steel locally and ensures a more promising future. Globally it supports the market for stainless steel castings, spigots and flanges, with the castings designed to be replaceable by stainless steel 3D printed components in future.



Pictures courtesy of Columbus Stainless



Name of member:
Columbus Stainless
Manufacturer:
Senior Flexonics
Location:
Cape Town, South Africa
Environment:
urban, rural
Grade and surface:
304, 309, 321, 316Ti,
Inconel 625

Automotive

Leisure and commercial hardtop storage solutions

Grade 409 stainless steel featured throughout their entire SmartCanopy range, Rock Solid Industries (RSI) uses Life Cycle Costings (LCC) to effectively educate and demonstrate to their customers the advantages of stainless steel. Catering to a wide range of industries which includes specialised commercial



fleets, RSI's advances in product design and manufacturing techniques have led to the development of strengthened products with a reduced weight, growing their product offering to compete with traditional fiberglass and aluminium canopy manufacturers.

Their SmartCanopy range features a modular design that comprises just five main parts that are bolted together into a patented design. Easy to assemble and with replaceable parts, it offers a complete knock-down flat pack solution which is already revolutionising the canopy industry.

Meeting the ISO 9001:2015 and TUV Certified requirements, advances in their latest TUV specifications include solid side panels (complete sleeve) which have reduced the weight and strengthened the overall canopy structure. Eco-friendly with a comprehensive warranty and reduced logistical costs, the SmartCanopy range is set to take on the fibreglass market aggressively with the launch of their latest SmartCanopy Evo design, which is 100% recyclable, offers improved functionality and has the benefits of their TUV spec, and has been made possible through new technology in sheet metal forming which RSI has recently invested in.

Sassda Awards Judges' Comments:

For offering sustained high-quality and customised services to the transport industry for many years, this industry leader is a highly competent manufacturing business with the management team in sync and in close contact with the product and employees.



Name of member:
Columbus Stainless and
SASSDA

Manufacturer:
RSI SMARTCANOPY®
(Rock Solid Industries)

Location:
Pietermaritzburg and
Durban, South Africa

Environment:
urban, rural, coastal,
industrial

Grade and surface:
409

Competing materials:
aluminum, fiber glass,
plastic

Pictures courtesy of the Southern Africa Stainless Steel Development Association

Automotive

Lightweight stainless steel fuel filler neck for automobiles

Recently, more strict regulations are laid on the automobile manufacturers to produce the vehicles which can meet the emission requirements. A lighter car by reducing a vehicle's weight can significantly improve fuel efficiency and reduce exhaust gases.

Conventional fuel filler necks are made of carbon steel or engineering plastic. Carbon steel is cheap and has good formability to be fabricated. However, due to a low corrosion resistance, multiple protective paintings and coatings could not guarantee the required product's lifetime (e.g. 15 years/150k miles of California Vehicle and Emissions Warranty Periods). Engineering plastic has a couple of advantages of lightweight and manufacturing of complex shaped parts, but it has poor crashworthiness, and the lack of fire resistance. POSCO304XD is designed to assist customer's development of a fuel filler neck having lightweight and a longer lifetime for the product. It has been



developed to have sufficient ductility for multi-stage forming of fuel filler necks to prevent cracking during fabrication by optimizing the copper content of 304. In addition, due to the high strength of austenitic stainless steel, approximately 30% of weight reduction is possible compared to carbon steel fuel filler necks having the same structure. Finally, due to its good corrosion resistance, it is not necessary to apply an external coating or the minimal powder-type coating for surface protection. The good formability and ductility of POSCO304XD can be further utilized in other applications such as sinks and deep drawing parts. This grade can also be used in hydroforming where severe compressive deformation often causes delayed cracking.

Pictures courtesy of POSCO

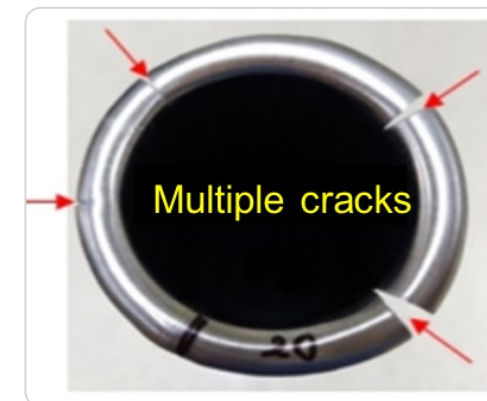

Name of member:

POSCO

Manufacturer:

SAMBO Motors

Location:

Korea, US

Environment:

urban, rural, industrial

Grade and surface:

304XD and 2B

Competing materials:

carbon steel and engineering plastic

Ferritic stainless steel with enhanced formability for exhaust systems of hybrid and plug-in hybrid vehicles

Hybrid powertrains normally consist of an efficient combustion engine and an electric driving unit of motors and battery modules. So, the spaces for exhaust parts are going to be limited and the shapes of exhaust parts tend to be compact and complex. Moreover, the demand of lightweight exhaust parts guaranteeing longer lifetime would result in the selection of high chromium stainless steel as a preferred material.

The deep drawing property of the developed material is elevated 20~30% higher than conventional ferritic grades. The 180 degrees bending of pipes made with conventional and new developed ferritic stainless steels show clearly the benefit of the enhanced formability. The wrinkling defect during bending is diminished by adopting the developed material. The deep drawing stamping of muffler caps in exhaust parts of a compact-sized vehicle demonstrates that necking fracture

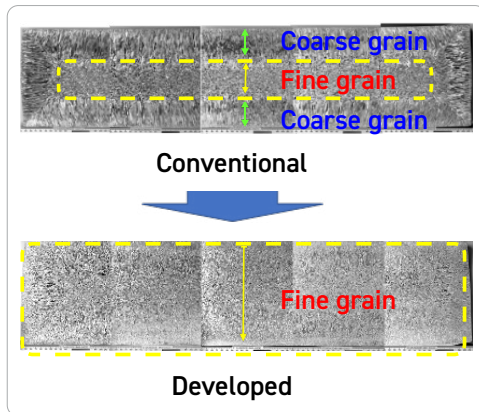

Figure 1: Comparison of conventional and developed slab grain structures

Pictures courtesy of POSCO



Figure 2: Pipe bending with conventional and developed ferritic stainless steels
Picture courtesy of POSCO

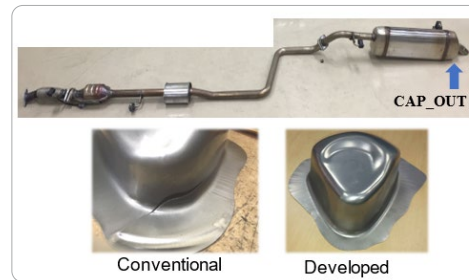

Figure 3: Stamping trials of muffler caps with conventional and developed ferritic stainless steels
Picture courtesy of POSCO

by thickness reduction in the deformed part is reduced negligibly as a result of the good formability. In addition, more uniform thickness distribution in the deformed part allows to make it thinner and lightweight. The other distinguished property of the developed material is the good mechanical toughness in the welding zone. The TIG welded zone of the developed material shows finer grain structures than conventional ferritic grades. This contributes to the improvement of ductility in the welded zone and then reduces cracks and tearing near the welded zone in the subsequent forming operations after welding. Lastly, enhanced formability can be further utilized in deep drawing applications in other industries.

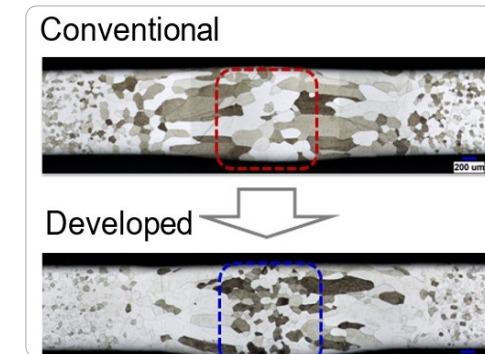

Figure 4: Comparison of weld-zone grain structures between conventional and developed ferritic stainless steels
Picture courtesy of POSCO



Name of member:
POSCO
Manufacturer:
Sejong
Location:
Korea, China, EU, USA
Environment:
urban, rural, industrial
Grade and surface:
STS439 (Poss439XF) / 2B
Competing material:
austenitic stainless steel

Automotive

Folded stainless steels create a new concept in bend-formed body structures for small electrified urban vehicles

Stainless steels are well-known for their excellent formability. Outokumpu is demonstrating the suitability of temper-rolled austenitic stainless steel with $Rp0.2 \geq 800$ MPa for the manufacturing of body structures for the fast-growing sector of small urban electrified vehicles classified by the EU as L7e-vehicles (total vehicle weight ≤ 450 kg without batteries).

In this sector, many start-ups and local manufacturers do not have the established manufacturing lines, investment-intensive deep-drawing tools and cost-intensive coating lines that

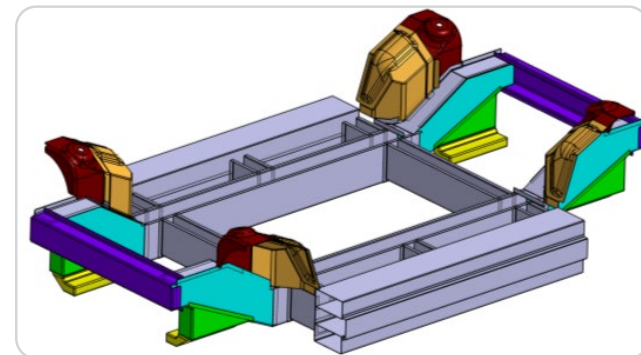

Bend-formed vehicle structure (< 180kg) manufactured only with austenitic temper-rolled stainless steel in two strength levels (dark blue for base material yield strength level of 800 MPa, lighter blue for yield strength level 500MPa).

would enable them to compete with the major OEMs. For example, the current state-of-the-art for a body-in-white construction is a steel-intensive design with 600 parts and up to 6,000 spot welds, while forming tools and presses require an investment of up to €2 million per tool.

L7e-vehicles are not only a significant challenge for lightweight design but also for crash safety. Currently, there are no vehicles in this category that meet the official crash requirements of M1-category vehicles like Smart or VW Golf. To eliminate the drawbacks of the traditional approach, the advantages of temper-rolled ultrahigh strength austenitic stainless steels have been utilized with a new design methodology for vehicle structures inspired by folded packing cases. The manufacturing steps for the floor structure and parts of the pillars require only tool-less bend-forming and one welding procedure to create a folded and therefore stiff lower vehicle structure.

Pictures courtesy of Outokumpu

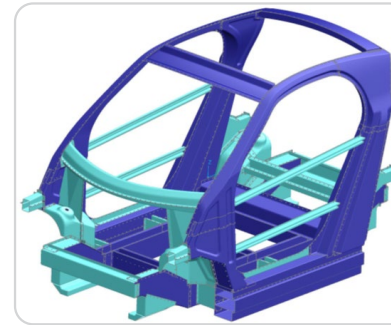

Bend-formed stainless floor structure for safety integration of battery modules, designed as a cost-effective common part strategy.

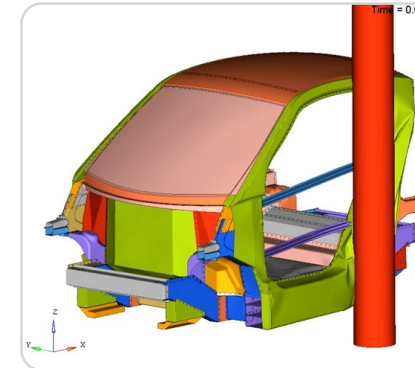

Successful withstand during crash simulation of the bend-formed stainless vehicle according to EuroNCAP lateral side impact. This stainless steel bend-formed vehicle is the first L7e-vehicle (<450kg weight without batteries) to reach successfully the crash requirements of M1-category vehicles (like Smart and VW Golf).

The material properties combined with the folding principle to halve the number of individual components and welds. This results in a much lighter structure (less than 180 kg) with increased crash safety that is constructed by more simple, cost-effective manufacturing processes with shorter cycle times as well as lower CO₂-emissions over the whole vehicle lifetime.



Name of member:

Outokumpu Oyj

Developer:

Fka Aachen

Location:

Aachen, Germany

Environment:

urban

Grade and surface:

temper-rolled austenitic stainless steel

Competing materials:

hot-formed ultra-high strength carbon steels and aluminium extrusion profiles

Food and beverage production

Stainless Steel RDA Units

This RDA Valve technology has many varying applications. Not only is it used extensively in the food industries it is also used in applications with chemicals at high temperature making stainless steel the natural choice. ND Engineering as a company has almost 40 years of experience when it comes to the fabrication and welding of highly alloyed materials. This experience has allowed us to meet the special welding and fabrication needs of this exciting new technology. ND Engineering has been able to retain the manufacturing of the new valve technology in South Africa through a combination of cost competitiveness and manufacturing quality.

Considering that we have been involved in the development process from the initial concept Valve units, through to the pilot valves and finally the production valves, it is most rewarding to have maintained our partnership with Ionex as a strategic partner.

Even under great pressure to manufacture this technology in China, Ionex Separations Technologies has given ND Engineering their full support in retaining the manufacturing in South Africa for the RDA units which has seen the market expand into Europe with our latest order for Hungary requiring the CE marking.

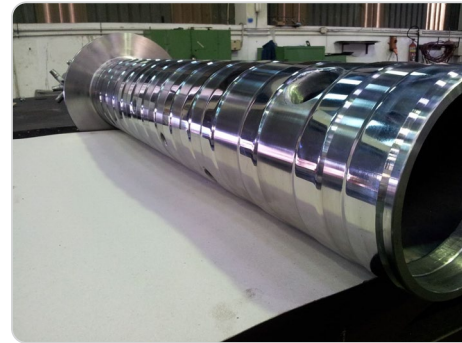

Pictures courtesy of ND Engineering



Name of Member:
SASSDA
Manufacturer:
ND Engineering
Location:
South Africa and Africa
Environment:
indoor
Grade and surface:
316L, 2205, 254MO,
904L

Food and beverage production

Manufacture of biomass stoves and potskirts

The stove was developed by Adrian Padt and Aidan Oosthuysen, and Richard Pocock, and uses a familiar Rocket design surrounded by a wire cage to improve the stove's stability and reduce burns. It's a smart looking stove, it saves women time and energy in gathering firewood, and it has lower emissions than the solutions it is typically



replacing.

- The Rocket Works stove is a high efficiency wood burning stove, designed to accommodate multiple fuels when required.
- It is smokeless after initial combustion, thereby reducing the likelihood of carbon monoxide poisoning and reducing the emission of black carbon particles.
- The outer cage remains cool to touch even after hours of cooking, due to our innovative design.
- It is made from high quality, heat resistant stainless steel allowing for years of regular use.
- It can boil 5 liters of water in 15 minutes using as little as 250 g of wood, which is significantly less than traditional cooking methods.
- Its thermal efficiency is 45%, for the Large Pot High Power, performed by the SeTAR Thermal Efficiency Test.
- Its emissions are the best in its class.

Pictures courtesy of Rocket Works



Name of Member:
SASSDA
Manufacturer:
Rocket Works
Location:
South Africa and Africa
Environment:
indoor
Grade and surface:
430

Food and beverage production

ABACO Anti-bacterial coating

ABACO® is an antibacterial coating that combines the advantages of strength, durability and beauty of PVD (Physical Vapour Deposition) with an assured nanotechnology providing exceptional antibacterial properties. It is able not only to completely inhibit the growth of bacteria but also to eliminate them, guaranteeing a durable and perfectly hygienic surface. ABACO® has therefore not only a bacteriostatic effect, but it is also bactericidal. The bacterial efficiency, certified by a precise lab test, is

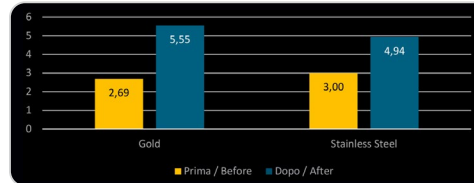
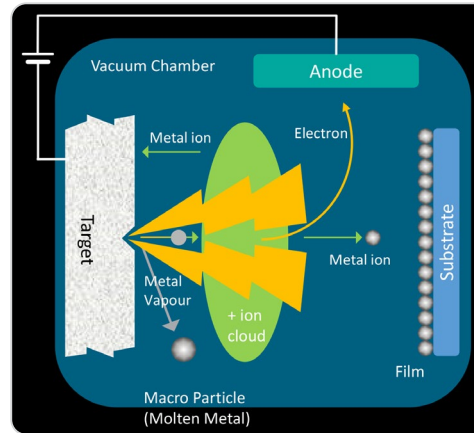

due to the nano inclusions present in the complex architecture of the multilayer coating, which destroys the bacterial cell membrane by blocking its nutrition, thus stopping the cell division cycle. The antibacterial action continues throughout the active life of the object. This antibacterial coating can be applied on a wide range of stainless steel products, such as gastronomy, containers, lids, baking pans, trays, sink bowls, basins and accessories for ice-cream shops and much more.

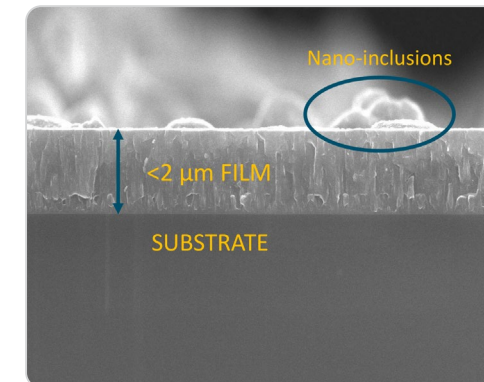

Pictures courtesy of Centro Inox



Name of member: Centro Inox
The ABACO® Project has been supported by:

- Protec Surface Technologies Srl (PVD antibacterial equipment)
- Protim Srl (PVD antibacterial coatings)
- MORI 2A Srl (specialized in designing and manufacturing of stainless steel products for the HO.RE.CA industry)
- Almar SpA (antibacterial door handles)

and financed by:

- Regione Lombardia
- MIUR - Italian Ministry of University and Research

Environment: indoor

Food and beverage production



Stainless steel bottles

The all-Italian innovative “24 Bottles” brand was created in 2013 to rediscover the theme of sustainability. The first collection of EN 1.4301 (AISI 304) stainless steel bottles was designed for the purpose of containing and limiting the use of disposable plastic bottles and glasses. The choice of using stainless steel has allowed to produce bottles that are as light as aluminium canteens, strong but at the same time safer and healthier, since they have no plastic internal lining. In addition to the collection of stainless steel bottles, this manufacturing company proposes a line of original and exclusively “made in Italy” fashion accessories.

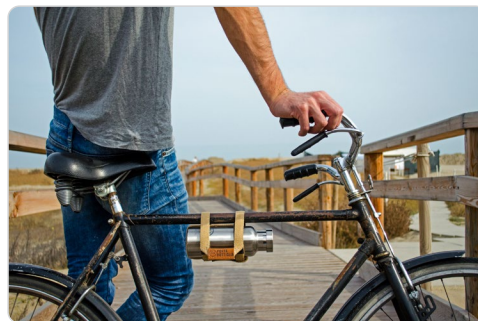

Name of Member:
Centro Inox

Manufacturer:
24Bottles® is a registered trademark of
DESIGN24-40055
Villanova di Castenaso
BO – ITALY –Via
Bruno Tosarelli 284,
www.24Bottles.com

Designer:
Luca D'Ambrosio

Environment:
urban, indoor

Grade and surface:
304 (EN 1.4301) and
painted stainless steel

Food and beverage production

Solar drier

Due to the economic conditions in the country most schools have vegetable gardens to feed the children. The problem is that these gardens are seasonal and still creates supply problems for the rest of the year. The other source is fruit donations from supermarket chains however the same seasonal problem remains.

The objective remained to design a device to increase the life span of the vegetable and fruit. That is when the organisation Feed a Child came up with the idea of solar fruit driers.

This is a very simple design but very practical. It is manufactured with 3CR12 stainless material. The frame is from stainless with a solid stainless back plate. At the front it is covered with a plastic product to let the sun through creating heat. Hot air will flow upwards and dry the fruit and vegetables. There are 8 racks that slide in and out on which the fruit and vegetables are dried on. The dimension of these racks is 2435 mm by 390 mm. The total height of the drier is 2 m. The base is 1230 mm by 2435 mm.

The first prototype drier was completed February 2017. The first trial started with this drier was very successful. The plan is to manufacture more of these driers and place them in strategic locations in the communities where needed. With the water problems in our country it will definitely add value to the life of people.



Jenny Nawa from Feed a Child feeding vegetables to be dried in feeder.



Name of Member:
Columbus Stainless

Partner:
Feed a Child and Africa Outreach

Manufacturer:
Mpumalanga Stainless Initiative

Location:
Middelburg,
Mpumalanga

Environment:
rural

Grade and surface:
3CR12 Stainless with
2B finish

Food and beverage production



Pictures courtesy of Centro Inox

Stainless steel trays instead of disposable containers in the school dining halls

Starting from September 2017, in the Municipality of Scandicci, 850 "gastronorm" containers in stainless steel, with their lids, were introduced for the school catering, instead of the disposable containers in polypropylene. The stainless steel containers are used for the packaging and distribution of food and are cleaned and sanitized at the end of the meal. The municipality of Scandicci is another example, after that of the municipality of Milan, dating back to 2012, where the school dining halls, for greater respect for the environment and also for better hygiene, decided to choose stainless steel.



Name of Member:
Centro Inox
Manufacturer:
Italian catering
cooperative: CIR food
Location:
Scandicci (FI), Italy
Environment:
indoor
Grade and surface:
EN 1.4301 (AISI 304)
stainless steel

Food and beverage production



NDF 250-man Mobile Kitchen

A reputation for creating some of the world's toughest off-road trailers, manufacturer and exporter Desert Wolf Consulting is a preferred supplier to the South African National Defence Force for its diesel cooking burning technology. Its Boma 250-man Field Kitchen is a tour-de-force. With its unique design, together with its significant stainless-steel component, the development of their smokeless diesel burners has allowed portable kitchens to be independent of difficult to access LPG gas supplies. With no diesel stoves with the required capability available on the market at the time, the rugged Desert Wolf BOMA 250 - man 4x4 mobile – and smart kitchen – was born. Powered by a tablet, it seamlessly links planned menus with ingredient orders from the army stores and provides for a range of menus. Burning cleanly with no smoke emissions, its unique design allows two chefs to stand opposite each other rather than side by side, resulting in better work flow with access to the oven and frying surface. Its diesel fired technology is now being implemented in the new SANDF 50 and 200-man containerised



field kitchens will form the heart of military kitchens featuring uniquely South African designed technology. Sasdda Awards Judges' Comments: For designing a brilliant, novel, mobile bush catering solution, using only diesel, and utilising sophisticated 4th Industrial Revolution technology.



Name of member:
Columbus Stainless and SASDA
Manufacturer:
Desert Wolf Consulting
Location:
Pretoria, South Africa
Environment:
rural
Grade and surface:
304

Pictures courtesy of the Southern Africa Stainless Steel Development Association

Food and beverage production

Martensitic stainless steel for knife blades and cutting tools

Thanks to their high-degree of hardness, martensitic stainless steels guarantee a good cutting edge. However, to get this level of hardness requires the use of a high level of carbon content – a content that depletes chromium carbides during heat treatment and thus leaves the stainless steel more susceptible to corrosion. Although the corrosion resistance of high carbon grades can be improved by adding molybdenum, doing so is extremely expensive. As an alternative, Aperam introduces its nitrogeninfused MA5 grade. Not only does nitrogen offer the hardness advantage of carbon, when combined with an increase in chromium content, it also improves corrosion resistance – without the need to add molybdenum. Because MA5 offers a high degree of hardness and improved resistance to corrosion, it has been quickly embraced by the cutlery and kitchen utensils market, who regularly uses it in manufacturing knife blades and other cutting tools.



Name of member:

Aperam

Environment:

indoor

Grade and surface:

MA5 (Martensitic Grade)

t 0.4~6.0 mm

Competing materials:

carbon steel, ceramic

Electrical machinery



3CR12 Substations

These modular sub stations used to be made of carbon steel but since 2011 they have been manufactured from painted 3CR12 HRA to address the needs for longevity, off-site credibility and potential corrosion resistance.

3D modelling is used to design each bespoke unit – each unit must be 'a fit' for the expense equipment that it is going to contain and therefore the unit is modelled as a 'solution' for the particular project. The content are a huge capital expense and the unit needs to be designed to protect these assets.

For this application they have moved away from welding (less likely to fatigue or crack) and now use a hydraulic swaged bolting system. This system cuts down on the labour requirement as it is a far quicker process, however, extensive preparation of the individual components is required.

They are superior to any other offerings of their type and can be up to 40 meters long, 6 meters wide, with a internal height of 3.5 meters and a total weight of 90 tons. If a larger substation is required they can add on to this with modular

solutions.

Environmentally friendly, once one project has been completed the unit can be uplifted and move to the next project – they are 100% mobile. The units have an explosion rating for Oil and Gas or Petrochemical applications, the units are positively pressurized, and they need no crane to lift them – they operate with hydraulic lifting.

Currently Efficient Engineering are building 13 units for mines in Botswana as well as for a local Petrochemical company.

Name of Member:
SASSDA
Manufacturer:
Efficient Engineering
Location:
South Africa and Africa
Environment:
outdoor
Grade and surface:
3CR12 HRA

Electrical machinery

Residential energy storage system

Since the Great East Japan Earthquake of 2011, Japan's power situations have entered a period of drastic changes.

The residential energy storage system offered by NEC has attracted attention as it is a smart system to store electricity without waste and is used when needed. For example, if consumers store electricity of lower rates offered at midnight and use it when needed, they can reduce their electricity charges. In addition, such electricity storage/usage contributes to decreasing the peak demand in their communities. They can also use the system as a backup for emergency in case a blackout occurs. To promote the use of the Residential Energy Storage System, a low price and high quality are

essential conditions. SUS443J1 used in the System is a superb material, which does not contain nickel, a rare metal, and is not only low and stable in terms of price but also has corrosion resistance at least equal to or better than the conventionally used SUS304.

The System made with SUS443J1, a resource-saving and environment-friendly material, will continue to maximize energy resources in the future. In the future, the construction of common ditches extending approximately 240 km are planned nationwide and the demand for SUS304 products is likely to rise, enabling the parties to make a further social contribution.



Picture courtesy of the Japan Stainless Steel Association



Name of Member:
JSSA
Manufacturer:
NEC Corporation
Location:
Japan
Grade and surface:
SUS443J1

Electrical machinery

Stainless steel electrical enclosures

The electrical enclosures for BHP's Olympic Dam were custom-designed for the client and are now a standard specification for future installations at this site. Electrical enclosures are used across various industries, from mining, oil and gas to industrial and commercial buildings. Many other materials are used – aluminium and zinc coated steel for example – however stainless steel offers a more cost-effective, durable and long-term solution, and aesthetic appeal depending on the application. Stainless steel will always perform regardless of the application in which the enclosure is used. This is a good opportunity for materials substitution, promoting stainless steel as the material of choice and delivering positive results for market growth.



Picture courtesy of MPS Building and Electrical



Name of member:
ASSDA

Manufacturer:
B&R Enclosures (with material supplied by Outokumpu)

Location:
BHP's Olympic Dam (mining site), South Australia

Environment:
industrial

Grade and surface:
grade 316 with a no.4 finish

Competing materials:
zinc coated steel, aluminium

Green energy production

Biomass wagons

200 new wagons made in ferritic stainless grade 3Cr12. Each vehicle has a capacity for transporting biomass almost 30% higher than other UK wagons. The load capacity is 71,6 tonnes. Pelletized biomass will be transported from the ports of Tyne, Hull and Immingham to the Drax power station in North Yorkshire.

The wagon's shape held the key. By working on its design, UK engineering company WH Davis achieved a significantly increased cubic capacity. The wagon has a 3Cr12 stainless steel main structure, chosen in key part due



Pictures courtesy of Columbus Stainless

to its higher corrosion resistance and reduced friction to mild steel. 3Cr12 is recognized as the original 12% chromium utility ferritic stainless steel, due to its toughness (even when welded), and its capacity of retaining toughness at temperatures below freezing point. Its performance resists high levels of corrosive attacks, especially storage and abrasion resistance in materials handling, which all contributes to reduce reparation costs in many engineering site applications. In general it can be shown that in real industrial situations, where corrosion is present, 3Cr12 is shown to be vastly superior to carbon and low alloy steels. When the cost per unit volume loss is also taken into consideration, 3Cr12 is superior to all types of steel that have been tested. Other rail applications using 3Cr12 grades includes coal ore, sugar, agriculture, abattoirs plus, light rail and rail infrastructure road transport covers passenger vehicles coaches & buses, trucks & freight and utility vehicles applications.



Name of Member:
Columbus Stainless/
Cedinox

Manufacturer:
WH DAVIS

Location:
North Yorkshire

Environment:
industrial

Grade and surface:
ferritic 3Cr12;
hot rolled no.1

Green energy production

Application of Stainless Steel for Dori-kamu Foundation-Making Method (Foundations for Solar Panel Mounts)

Dori-kamu Foundation-Making Method is a method using steel containers loaded with heavy substances like stones and soil as the foundations for solar panel mounts, which can be placed irrespective of the environment and conditions of the ground. The Dori-kamu method has such advantages as omission of soil/stratum surveys and shortened construction time over the common practice using pilings.



Pictures courtesy of the Japan Stainless Steel Association



The mega-solar system shown in the pictures was installed in a coastal area subjected to chloride attack and considering the corrosion resistance and durability required of the material, stainless steel has been adopted for the first time. Of various stainless steel types, NSSC FWR Series (Equivalent to SUS430LX), a resource-saving type, has been selected, which, along with the generation of renewable solar energy, is expected to make huge contributions to reduce burdens on the social environment.

The combination of the Dori-kamu method and the selection of the stainless steel type suited to withstand any given corrosive environment will make it possible to install a solar power generation system where it was extremely difficult with conventional construction methods. Thus, the demand for the Dori-kamu foundation preparation method using stainless steel is expected to rise in the future.



Name of Member:
JSSA
Manufacturer:
TOMIYASU & CO., LTD.
Location:
Japan
Grade and surface:
NSSC FWR series
(equivalent to SUS430LX)

Green energy production

Collector electrode

Electrostatic Precipitators (ESPs) are units widely used to remove particulate matter from gaseous emissions. In general, ESPs comprise a wide range of equipment that also includes a substantial number of "Collector Electrodes" having their surfaces designed to facilitate particle precipitation and their effective removal thereafter.

The "Collector Electrodes" are arranged vertically and attached to the main structure by means of support brackets to form a "curtain" electrode assembly that is suspended in the gaseous emission within the ESP. Some of these gaseous emissions are highly corrosive and the relevant dust content can be highly erosive as well. Any dust that settles on the "Collector Electrode" is normally removed by means of striking the unit via an appropriate "rapping" device.

Use of stainless steel material 3CR12 to form an elongated plate which is rolled by means of a purpose built rolling machine to specific lengths in order to form dust collecting curtains used as internal elements in Electrostatic Precipitator Units. The individual sheet is termed as "Collector Electrode - S/S".

The main benefits of using the "Collector Electrode



Pictures courtesy of Columbus Stainless.

- S/S" Units are as follows:

- Higher corrosion resistance than mild steel which is especially important to the ESP when units are washed regularly;
 - Better impact resistance;
 - Better performance at high temperatures;
- The Gas Cleaning Industry has always been faced with process conditions which are extremely

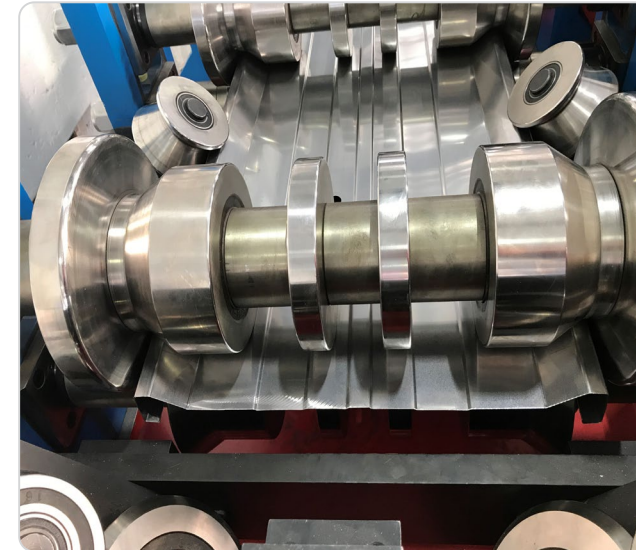

unfriendly to the use of normal steel materials in areas or equipment directly exposed to the various off-gas streams.

The replacement of mild steel with stainless steel in "Collector Electrodes" brings about a conversion of well established norms with emphasis on already detailed benefits.



Name of Member:

Columbus Stainless

Manufacturer:

Geecom (PTY) Ltd

Location:

Gauteng, South Africa

Environment:

industrial

Grade and surface:

3CR12/EN1.4003,
2B surface

Industrial machinery

Intermediate bulk container mixer systems

This range of Intermediate Bulk container (IBC) MIXERS (also known as TOTE or Flow Bin Mixers) are specifically designed to handle mixing duties within the container. The main feature of the design is found in a range of folding impellers. These impellers are based on a range of high efficiency hydrofoils that are able to fold in to facilitate fitting through the limited container opening, without the need for any modification to the container. Once a collapsed impeller is inserted into the container, with the folded diameter typically being half that of the whole diameter, the centrifugal forces on start-up force the impeller open. The stainless steel impellers are available in varying diameters from 132 mm (5,2") up to 435 mm (17,1") which allows for most application requirements. With the impeller being a hydrofoil the design offers the efficiencies of a fixed bladed impeller

system. The design results in lower power consumption whilst maintaining the same results. This improves the process efficiencies and reduces the mechanical loading on the agitator, reducing

mechanical loading allows the agitator to be lightweight and durable.

All mixers are manufactured to ISO 9001 standards and are CE certified.



Name of Member:
SASSDA
Manufacturer:
Afromix
Location:
South Africa and Africa
Environment:
outdoor
Grade and surface:
304, 316 and duplex
depending on the
product

Pictures courtesy of the Southern Africa Stainless Steel Development Association

Industrial machinery

Anderson Contramix

Anderson Engineering is well recognized for its range of innovative mixing solutions. It is an integral part of all our turnkey project work. We conceptualized, designed and manufactured mixing vessels for a range of clients and industries. The "Rolls Royce" of our mixing vessels is the Anderson Contramix. It is a highly innovative and efficient mixer for a range of mixing combinations of liquids and solids. It is used for the agitation of mainly

viscous products by combining slow movement (with scrapers) close to the tank wall with faster or slower movement at the center of the tank (mixing elements), together with a high shear emulsifier at the base of the vessel.

The Anderson Contramix offers the



ultimate solution in high viscosity mixing. It is a low shear, high product turnover mixer designed specifically for emulsions, suspensions and pastes such as creams, syrups, ointments and sauces, which achieves the high shear requirements from the emulsifier during the critical stage of product manufacture. These products, by their nature, contain basic ingredients which are normally miscible (such as water and oil). This is however achieved with the Contramix during the emulsification phase. A vacuum is used to successfully introduce smalls (such as small

amounts of powders and solutions) into the mixing vessel and a recirculation process is used to improve the dispersion of ingredients.

The Anderson Contramix can be manufactured in sizes of as small as a 20 liters up to a 6,000 liters mixing vessel (using up to 1,5 tons of stainless steel). It can be used at a temperature of up to 900 °C, shampoos and conditioners, hand washes, and a range of food products.



Name of Member:
SASSDA
Manufacturer:
Anderson Engineering
Location:
South Africa
Environment:
indoor
Grade and surface:
304 polished

Industrial machinery

Anderson and Pure Magnetic Mixer

Our extensive range of customized mixing equipment is a core strength of Anderson Engineering and an integral part of our project turnkey work. The design and engineering of the highly innovative and unique Anderson Magnetic Mixer came about due to our need to find a solution for ultra-hygienic mixing for the pharmaceutical industry.

The conventional method of mixing is to utilize a shaft driven impeller or mixing blade which protrudes out of the vessel. This is normally supported with a bearing on the outside of the vessel and sealing at the point of entry to the vessel is achieved utilizing mechanical seals. To achieve an ultra-hygienic design with mechanical



seals is extremely difficult and invariably requires compromise on the hygiene aspect of the process. Failure of the mechanical seals commonly occurs. In certain circumstances this is not tolerable and this was an area that we identified our clients were experiencing challenges.

The magnetic driver system utilizes a stainless steel fabricated and fully welded casing, through which the mixing element is driven on the inside of the vessel however utilizing the magnetic fields from the outside rotor. This system therefore has no crevices or potential leakage points, solving the need for a completely sterile and ultra-hygienic mixer. It also improves operational efficiencies because there is less maintenance and upkeep of the system compared to the high maintenance mechanical seal system. The mechanical seals also inevitably get discarded and replaced periodically, while the Magnetic Mixer produces no waste and needs no replacement parts. The magnetic mixer system enables the client to manufacture products such as intravenous medications and other products which require such high standards of hygiene.

Pictures courtesy of the Southern Africa Stainless Steel Development Association



Name of Member:
SASSDA
Manufacturer:
Anderson Engineering
Location:
South Africa
Environment:
indoor
Grade and surface:
304 polished

Industrial machinery

Ferrochromium fines treatment centre

Tugela mining and minerals wanted the structure of the plant to be fabricated from painted steel and approached NSSC. They sold the idea of using 3CR12 to Tugela mining and minerals as the lower cost solution if one considers LCC. The award entry is important in that structural applications are the biggest potential growth area for stainless steels, globally. Also this is a classic example of where, using LCC, it can be demonstrated that stainless steel can be specified with resultant cost savings over the long-term.



Picture courtesy of the Southern Africa Stainless Steel Development Association



Name of Member:
SASSDA
Manufacturer:
Tugela Mining and Minerals
Location:
South Africa and Africa
Environment:
outdoor
Grade and surface:
3CR12

Industrial machinery

Corrodur 18 – a new martensitic medium nitrogen stainless steel grade for bearing applications

Deutsche Edelstahlwerke together with Schaeffler AG has developed a new middle nitrogen martensitic stainless steel, Corrodur 18, for bearing applications. Traditional bearing steels like 100Cr6 exhibit good mechanical properties, but are not resistant to corrosive media. Conventional martensitic stainless steels for use in bearings require high carbon and chromium contents in order to achieve the desired properties. However, they are prone to precipitate coarse carbides, which is a drawback in such applications. As an alternative, high nitrogen martensitic stainless steels feature favourable mechanical and corrosion properties as well as fine dispersion of carbides or nitrides, but at the expense of high production cost (since high nitrogen

contents require the use of pressurized metallurgy). Corrodur 18, which can be produced using a conventional route (electric arc furnace, hot rolling, and subsequent heat treatment), shows a high hardness combined with good impact bending energy and good corrosion properties. Furthermore, the medium nitrogen content induces a fine microstructure featuring a uniform dispersion of carbides. Corrodur 18 has better resistance to white etching cracks (WEC), a type of bearing failures, than 100Cr6. In addition, fatigue properties are comparable or in some cases even better compared to traditional bearing steels. Corrodur 18 does not only show promising properties to be used as bearing steel but is also characterized by the combination of low content of alloying elements and its standard production route, which can make it less expensive at the same time.

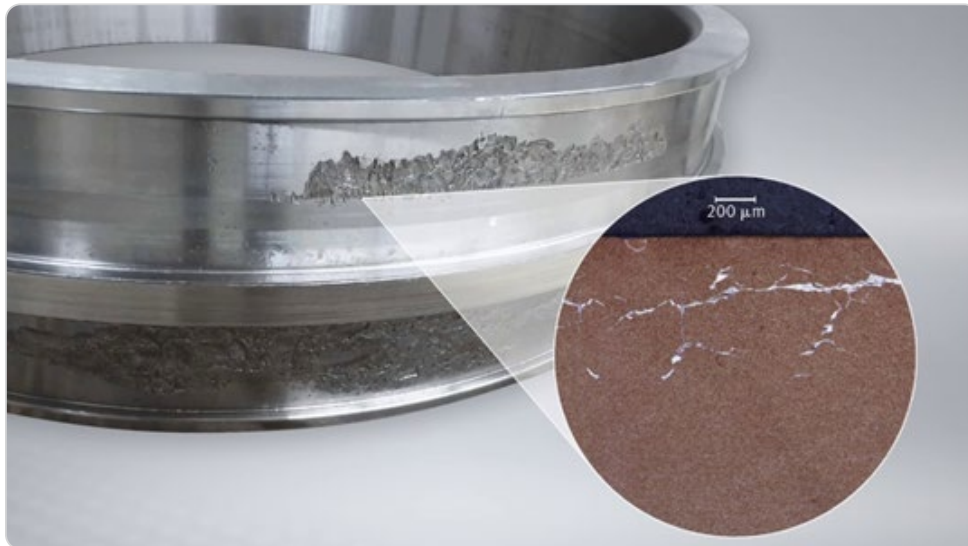

Picture courtesy of Schaeffler AG



Name of Member:

Deutsche
Edelstahlwerke
Speciality Steel
GmbH&Co KG

Manufacturer:

Schaeffler AG

Environment:

industrial

Grade and surface:

Corrodur 18

Industrial machinery

Fuchs Lubricants Australasia purpose-built plant

The expansion of food industry technology into industrial projects in such areas as stainless steel design and fabrication of high integrity and efficient interconnections of pipework, heat exchanger technology and contamination-free processing.

Stainless steel was integral to the plant expansion project design and construction, being the material of choice in demanding environments that involve high heat and aggressive substances. Offering structural integrity and excellent corrosion resistance in high temperature applications, stainless steel is vital in the construction of tanks, pressure vessels, valves and pipework.



Picture courtesy of TFG Group



Name of Member:

ASSDA

Manufacturer:

Furphy Engineering and
TFG Group

Environment:

industrial

Grade and surface:

304/304L

Industrial machinery



Retainers made with high-purity ferritic stainless steel wire

Retainers in “bag filter collectors” support “filter cloths” to “filter” smoke dust and such substances as dioxins generated during incineration of various industrial production and treatment processes including mining, refining, cement, steel, rubber processing as well as general dust generated in fracturing and crushing operations, and work to maintain dust-collection effects.

In the retainers shown in the picture, “NSSC180 (SUS430J1L)”, a high-purity ferritic stainless steel type, has been adopted for the wire material. With superior characteristics of this type including anti-stress corrosion

cracking, corrosion resistance and strength demonstrated even in an environment of severely high temperature, these retainers are produced and sold as merchandise along with those in which 300-series stainless steel or carbon steel is used for the wire components.

These retainers have already been supplied to more than one steelmaker and in the future they are expected to find customers in other industries as well (waste treatment, paper making, cement, chemical plants, etc.).

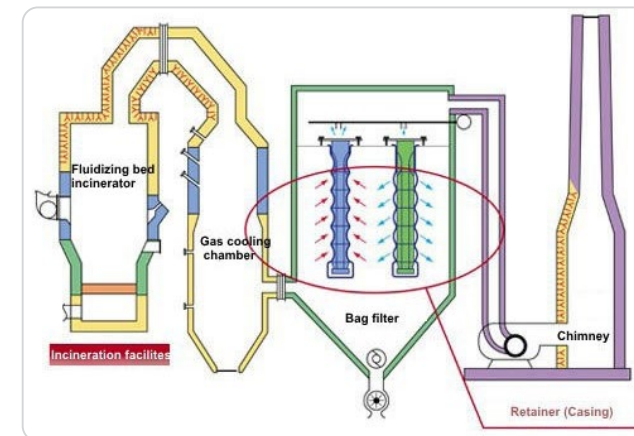

Name of Member:
JSSA
Manufacturer:
Namitakiko Co., Ltd.
Location:
Japan
Grade and surface:
SUS430J1L (NSSC180)

Industrial machinery

Stainless steel container for mining

The cable buckets used by mining operations for the onsite transportation of raw materials have traditionally been made of carbon steel. Unfortunately, carbon steel is very susceptible to corrosion, especially when used to transport carbon-rich and highly-corrosive coke. As the coke quickly erodes the material, the buckets must undergo regular maintenance, which in turn requires regular work stoppage and delays. At ArcelorMittal João Monlevade operations in Brazil, Aperam has proposed the use of stainless steel for the cable buckets. With a frame made from Aperam's 410 grade, the buckets have seen an increase in durability (with an estimated lifespan three times longer than carbon steel models) and a decrease in maintenance cost. Furthermore, because stainless steel is 30% thinner than carbon steel, the overall weight of the buckets has decreased, thus lessening the risk of derailment.



Name of Member:
Aperam
Manufacturer:
AçoTubo/ ArcelorMittal
Location:
João Monlevade -
Minas Gerais, Brazil
Environment:
outdoor
Grade and surface:
410/ NR°1

Pictures © ArcelorMittal

Industrial machinery

Therma grade for a baking furnace used to produce catalysts for oil refining

The Tianhua Institute of Chemical Machinery & Automation has fabricated a rotary baking furnace used by Sinopec, the Chinese oil and gas enterprise, to produce catalysts for the catalytic cracking of petroleum. It operates at 900°C and is manufactured from Outokumpu 253 MA plates measuring 2000x6360x18 mm. The addition of nitrogen (N), silicon (Si) and cerium (Ce) into the steel provides the plates with higher creep strength and improved corrosion resistance to oxygen. This ensures a longer service life that site tests have shown to be a 100% improvement on 310S.



Picture courtesy of the Tianhua Institute



Name of member:

Outokumpu Oyj

Manufacturer:

Outokumpu Oyj

Location:

Zibo, China

Environment:

industrial

Grade and surface:

Outokumpu Therma
253 MA, EN 1.4835,
UNS 30815, 1D

Competing materials:

310S and locally
produced UNS S30815
plates

Industrial machinery

Stainless steel floor for garbage truck hoppers

In the busy urban areas of Brazil, garbage trucks pick up a lot of trash – keeping the streets clean and the cities sanitary. However, due to the corrosive nature of the waste being collected, over time it begins to eat away at the hopper's carbon steel floor. As this corrosion increases, so does the risk for unsanitary and potentially hazardous leakage. Aperam's solution: stainless steel. A floor made of stainless steel type 410 increases a hopper's service life threefold, making sure the garbage stays inside where it belongs. As an added bonus, Aperam's stainless steel solution is environmentally friendly.

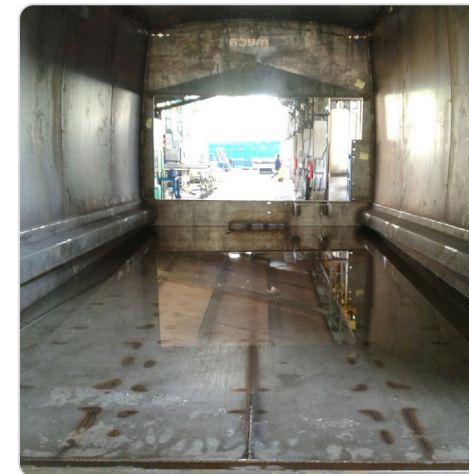

Pictures courtesy of Aperam

Name of member:
Aperam
Manufacturer:
Usimeca
Location:
Rio de Janeiro, Brazil
Environment:
urban, industrial, indoor
Grade and surface:
410 / #1
Competing material:
carbon steel

Industrial machinery



Picture courtesy of Aperam

Concrete mixer truck

Concrete is a highly abrasive material. In wet environments, the wear becomes much worse, due to the corrosion. Sent spinning around in a cement mixer and it's easy to see why these trucks have a relatively short lifespan. To improve the lifespan of these trucks, Aperam introduces the world's first stainless steel concrete mixer. After demonstrating that the use of stainless steel D410 internal cut pads could double the capacity of existing steel pads, Aperam went one step further and made an entire mixer bowl out of stainless steel. The use of stainless steel gives the mixer a thinner skin, thus significantly increasing its capacity. Furthermore, thanks to stainless steels' high resistance to corrosion, the average lifespan of a cement mixer is expected to be three to four times longer than today's steel models.



Name of member:

Aperam

Manufacturer:

Convicta

Location:

Brazil

Environment:

urban, industrial

Grade and surface:

410 / #1

Competing material:

carbon steel

Transport

Sailboat KAT - Schurmann Family

Easiness to clean, comfort and practicality are the main features sought in the materials used. Some of them were brought from abroad, but in the case of stainless steel, it is a domestic product. Supplied by Aperam, it was used on the deck, bathroom sink, furniture, floor and other structures.

"Everything that can be made of stainless steel will be made of stainless steel. It provides flexibility of shapes, it is lightweight and enables working with different sizes. In addition, it helped us overcome one of the main challenges of the project: associating function, shape and aesthetic with balance", says Jeane Bianchi, architect responsible for the interior of the boat. Advantage for those who design and those who will have the sailboat as home in the next two years. "The other sailboats didn't have a stainless steel deck. As time passed, the material was susceptible to rusting and it constantly needed scraping and



Pictures courtesy of Aperam



Name of member:
Aperam
Manufacturer:
Caçapava Shipyard /
Schurmann Family
Location:
Brazil
Environment:
outdoor
Grade and surface:
316L/2B
Quantity:
25 ton

painting. Now, instead of scraping and painting, I will invest my time in taking pictures and enjoying the landscape", banters Vilfredo Schürmann. This summary was quoted from the article from "Aperam".

Transport

Stainless steel yacht

The concept for building boats, developed by Swedish Steel Yachts, is a breakthrough in light weight, durable and environmentally friendly technology. It opens up a totally new application area/market for stainless steel - boats and smaller ships for the Police and Coast guard or for transportation.

The design utilizes the properties of the stainless steel super duplex 2507 in the hull and stiffeners. The alloy is extremely resistant to corrosion caused by saltwater. All metal under the waterline is mirror polished, which ensures that marine organisms that have attached to the hull are removed either with a low-pressure hose or at speeds as low as 5kn. This therefore avoids the need for environmentally hazardous and expensive anti-fouling paints!

The world patented light weight hull design utilizes the mechanical properties

of the steel and allows the boats to be built with much thinner sheets than is required for conventional steel boats. This allows a significant reduction in weight and results in significantly reduced fuel consumption.

All sheet metal is joined together with laser welding. The steel hull retains its mechanical properties despite tough conditions over a long period of time. This is a major advantage compared with plastic, carbon fiber and aluminum boats, which deteriorate over a number of years.

The hull is built in two meter wide Forta SDX 2507 sheets from Outokumpu and the stiffeners are delivered by Sandvik.

For additional information, see: www.ssy.se and: https://www.facebook.com/ssyab/?ref=page_internal



Pictures courtesy of Swedish Steel Yachts



Name of Member:

Outokumpu

Manufacturer:

Swedish Steel Yachts

Location:

Gävle, Sweden

Environment:

outdoor

Grade and surface:

Super Duplex 2507
from Outokumpu and
Sandvik

Quantity:

One built. One under
construction

Transport

SOx scrubber tower

The SOx Scrubber System works to purify exhaust gas emitted from marine engines through efficiently removing SOx (sulfur oxide) from such gas. It is an apparatus intended to reduce air pollutants to the levels set forth by International Maritime Organization (IMO), and this winning entry is the first such domestic product approved by the country where the ship concerned is registered.

The SOx Scrubber Tower is the central instrument of this apparatus, and its inside is exposed to a severely corrosive environment, for which corrosion resistance properties of carbon steel and such commercial-grade stainless steel as SUS304 are not sufficient. Thus, SUS329J4L, a duplex type, and SUS836L, a super-austenitic type, have been adopted for this critical component of the

apparatus.

The demand for the exhaust gas purification system contributing to the reduction of environmental burdens is expected to increase and this will lead to boosting new applications of highly corrosion-resistant stainless steel.

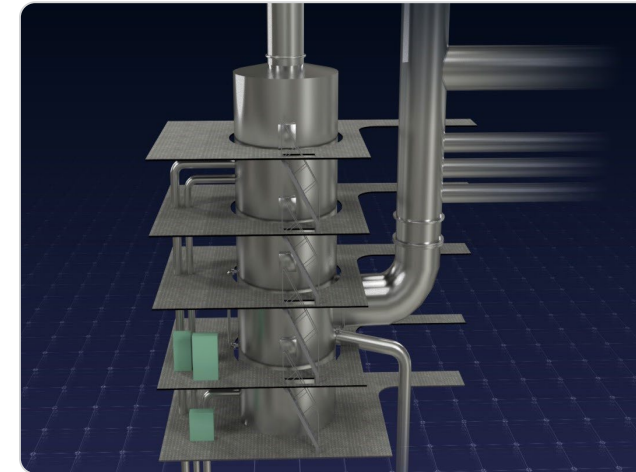
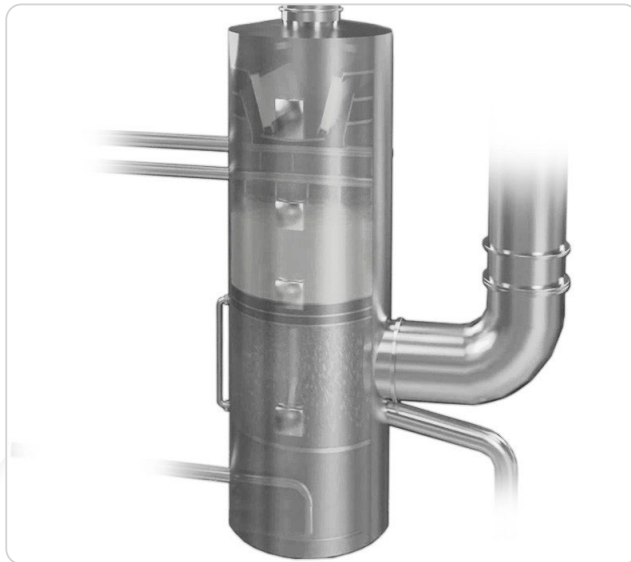

Pictures courtesy of the Japan Stainless Steel Association



Name of Member:

JSSA

Manufacturer:

Mitsubishi Kakoki
Kaisha, Ltd.

Location:

Japan

Grade and surface:

SUS329J4L, SUS836L

Transport

Conveyor belt self unloading stainless steel trailers

Profitability in the transport of bulk merchandise by truck depends in great measure on having the equipment that will haul the largest possible payloads at the lowest costs. The use of conveyor belt driven self-unloading trailers has proven to be one of the most effective means by which to reduce the unloading time of bulk commodities, resulting in a strong market for companies that



produce these types of trailers. One of the main producers of conveyor belt self-unloading trailers in the U.S. is "TRINITY TRAILER MFG. INC" headquartered in Boise, Idaho. Their "Eagle Bridge" design is a frameless trailer design that provides great strength while remaining light weight, made out of T304 stainless steel for those applications that require superior corrosion resistance. The frameless design allows the trailer to flex and twist as the trailer moves through different surfaces, due to this flex, the trailer will not break up as many rigid aluminum trailers do. For a number of products such as fertilizers, food products or wet feeds, corrosion is a major concern, the best option for transporting these types of merchandise is the use of stainless steel trailers. The stainless trailer utilizes NAS T304 grade stainless for both the panels and tubing that make up the structure. The trailers are both exposed to atmospheric corrosive agents such as salinity and humidity as well as possible corrosive agents contained in the products being hauled, such as acids, etc. T304 stainless is the perfect choice as it has superior corrosion resistance with a Chrome content of 17% and a Nickel content of 8%. North American Stainless (NAS) supplied the Stainless Steel through "Affiliated Metals" in 2B finish for this application.

Pictures courtesy of North American Stainless



Name of member:
North American
Stainless
Manufacturer:
Trinity Trailers Mfg Inc
Environment:
rural
Grade and surface:
T304 2B Finish
Competing material:
Aluminum

Transport



Pictures courtesy of Cubic Yachts LLC

Stainless steel yacht

In today's highly competitive Leisure Boat Industry, in order to stand out, a builder has to produce a boat which combines true innovation in design and materials as well as high standards in luxury and functionality. The company "Cubic Yachts LLC" out of Tampa, Florida has answered the call by building a yacht made out of Stainless Steel with a truly innovative cubic design that attracts a lot of attention wherever it goes.

The building material selected was T316L in 1/4" and 3/8" thickness produced by North American

Stainless (NAS) and sourced through Phoenix Metals. The grade was selected due to its high corrosion resistance and strength, making it an ideal choice due to the corrosive environment in which the vessel operates.

Designed by marine architect Fritz Schmid and interior decorator Cheryl Perotti, the Cubic Yacht is a luxury "Mobile Beach House". The vessel "Rendezvous 2018" is 9,000 square feet including 4,000 of AC space, 3,500 of decks and 1,500 of mechanical and storage.

Although it can be sailed in open seas due to its seven feet of distance between the water line and the deck, it was designed mainly to be operated in shallow waters close to the coast line where it can deploy one of the more interesting features. Once it reaches shallow water, the yacht can deploy four 18- foot hydraulic legs with a lifting capacity of a million pounds each, making the boat stand up out of the water so there is no motion of waves or wind.



Name of member:

North American
Stainless

Manufacturer:

Cubic Yachts, LLC

Environment:

marine

Grade and surface:

T316L 2D

Competing materials:

aluminum, fiber glass

Transport



Stainless steel power pack

A new regional transport train called "Rock" has been designed and built by Hitachi Rail Italy for Trenitalia. The double-floor electric train minimises consumption and has been designed to group all converter units (which transform the continuous 3000 volts current into alternating power), into an "above carbody" assembly. This Power Pack structure built using Centro Inox technical advice was made using EN 1.4404 (AISI 316L) stainless steel in sheets and a welded tube with rectangular section.



This structure has a dimension of 5000x2020x630 mm and weighs 1250 kg. Each train, which normally consists of 4 to 5 coaches, has two Power Packs installed – one positioned at the top of the train and the other at the rear. The stainless steel choice was motivated by the fact that it can simultaneously guarantee a material with excellent workability characteristics, reduced need for maintenance and resistance against corrosion.



Name of member:

Centro Inox

Manufacturer:

Hitachi Rail Italy Spa
- Via Argine 425 -
I-80147 Naples - Italy
italy.hitachirail.com

Grade and surface:

EN 1.4404 (AISI 316L),
externally painted with
epoxy paint

Pictures courtesy of Centro Inox

Transport



Stainless steel bicycle

This application is interesting, not only for the remarkable originality, but for the study and the production process adopted. Using stainless steel to realise a bicycle frame could seem a contradiction, due to the considerable specific weight characterizing this material with respect to other materials such as aluminium, titanium alloys or carbon fibres. However, the total weight is absolutely "competitive." The processing involves the laser "drilling" of the stainless steel. This guarantees a sequence of full and empty sections to provide adequate rigidity and robustness. But there's more! The designer wanted these limited

edition bicycles to be tailor-made for customers. This was allowed by the extreme versatility characterising the stainless steel (in this case EN 1.4301/AISI 304) and the fact it can be specially moulded for an increasingly demanding and elitist public.

Pictures courtesy of Centro Inox

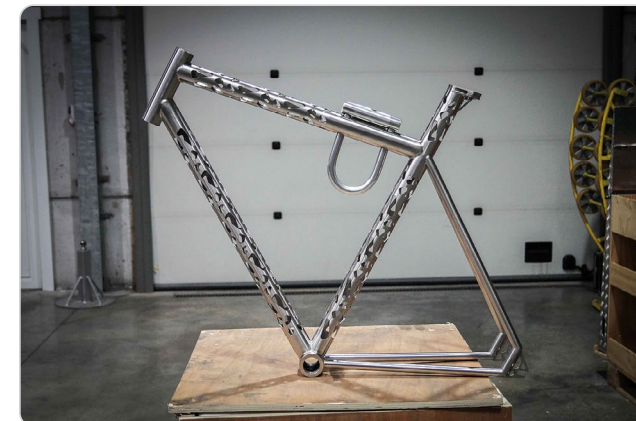

Name of member:
Centro Inox
Design:
Tobias Knockaert
(Industrial Designer
@ Eleventwentyseven,
Innovation Engineer @
D'Haene - Brugge,
Belgium - dhaene-nv.
be,
eleventwentyseven.be)

Made by:
V.A.C. MACHINES nv/
sa - Brugge, Belgium -
vac-machines.be

**Employed laser
machines:**
TRUMPF GmbH,
trumpf.com

Environment:
urban

Grade and surface:
EN 1.4301 (AISI 304)

Other

Stainless weldable sandwich with 3D-profiled core

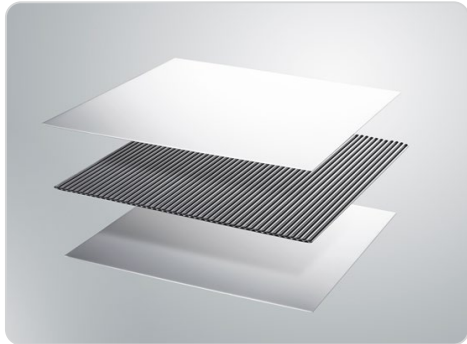

Layer set-up of Outokumpu's Stainless Weldable sandwich with a stainless 3D-profiled core and polymeric material plus two thin stainless outer-layers

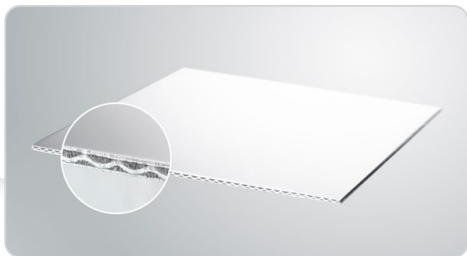

Outokumpu's Stainless Weldable Sandwich with a focus on the stainless 3D-profiled core and the metallic contact to the outer-layers

The Stainless Weldable Sandwich with a 3D-profiled core is the first direct weldable (stainless) steel-polymeric composite structure ("sandwich") for the automotive car body, transport and construction engineering industry. Former sandwich solutions had not been successful in spite of their enormous lightweight potential because of their insufficient weldability. The Stainless Weldable Sandwich is now able to combine the automotive challenges consisting of lightweight (-25%), stiffness (+80%), acoustic, energy absorption, crash safety and deep-draw-ability with a weldable solution. The 3D profiled core enables at every time a metallic contact between both thin stainless outer-layers which results in a constant electrical current during resistance welding. Thereby no changes during

manufacturing are necessary: The Stainless Weldable Sandwich can be handled like a conventional steel sheet during component manufacturing. The Stainless Weldable Sandwich will accomplish a key contribution for the lightweight and CO₂-emission targets with high safety at the same time. Furthermore, the Stainless Weldable Sandwich offers a high flexibility and can be adapted to the requirements of the final application: As one example, it is possible to combine a high corrosion resistance stainless steel on the one outer-layer with a more cost-efficient stainless steel on the other outer-layer side. The new sandwich structure solution enables the material "stainless steel" new possibilities in markets, where stainless steels were not represented in the past.

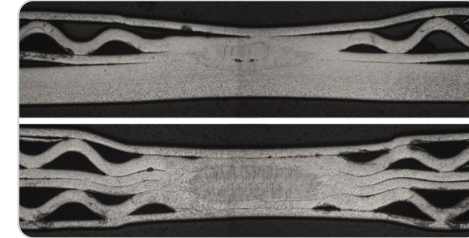

Weldability of Outokumpu's Stainless Weldable Sandwich, here: resistance spot welding in a lap-joint configuration with sheet thicknesses in each case $t = 1.5\text{ mm}$



Outokumpu's Stainless Weldable Sandwich offers also a high ability to other joining methods like the mechanical joining process of riveting. Because of the stainless 3D profiled core, the connection results in an outstanding power transmission with an enormous, state of the art not possible compressive rigidity. Background is the possibility to work out an interlocking between the profiled core inside the sandwich and the rivet



Name of member:
Outokumpu
Manufacturer:
Outokumpu
Location:
Krefeld, Germany
Environment:
industrial
Grade and surface:
flexible/various

Other

Shark Rover submersible

Seascope was commissioned to manufacture the two-person cage in June 2015 and it was specifically designed to film great white sharks. It weighs about 90 kg, is 1.3 m in diameter and 3.3 m long and is manufactured from grade 316 steel tubing and sheetmetal. The design for the shark cage was done by a UK based company, Marine Imaging Technologies. At the stage of order, Seascope was the only South African company that could complete the project in the time



allowed.

The stainless steel tubing of the cage allows for large open spaces between them to accommodate the cameras, which allows for a 360° view for undisturbed footage underwater. The cage's rudders and tillers enable it to move forward, sideways and in an upward and downward motion. Polyvinylchloride tubes were added to act as buoyancy members. The project was completed in a month and all tests went well. The cage has been used for local shark filming and is currently deployed off the coast of Mexico.

Good design, stainless steel combined with skills and commitment, showed a truly world-class product as result. This product can be seen as that what the South African stainless steel industry stands for in terms of world-class quality.

Seascope now ranks as the prime supplier of stainless steel components to the South African marine industry and is currently Africa's biggest supplier of stainless steel products to the global marine industry. Seascope is currently also a finalist in the Cape Chamber of Commerce's Exporter of the Year competition.



Name of Member:
SASSDA
Manufacturer:
Seascope Stainless Steel Services
Location:
South Africa and Africa
Environment:
outdoor
Grade and surface:
Grade 316

Picture courtesy of the Southern Africa Stainless Steel Development Association

Other

High Nitrogen (above 2000ppm) and Low Nickel (~3.0%) alloyed High Strength Austenite Stainless Steel (QN1803/304D) with no less Pitting Corrosion Resistance than standard 304

304 standard austenitic stainless steel with 18Cr-8Ni alloyed, has been extensively applied in various applications due to its excellent workability, corrosion resistance, formability and weldability for over half a century. The strength of 304 at annealed condition is, however, too low, being only at 235MPa level, which could not meet well the requirements in many fields, such as construction and building, art and street furniture, home and office appliance, cookware, transport, etc, where corrosion resistance and hardness or yield strength should be maintained high. In addition, 8% nickel gives the product of 304 a high alloy cost and also a risk as the nickel price fluctuates. Because of its low corrosion resistance, the standard high manganese and 3~4%Ni alloyed 200 series austenitic stainless steel cannot replace 304 in those applications although it has much higher strength.

There is, therefore, an urgent need for developing a new type of austenitic stainless steel with no less corrosion resistance and higher strength and an even lower cost as compared to 304 in those applications where both corrosion resistance and strength are highly required. Tsingtuo Group, a Tsingshan Industry Holding Company, has developed QN1803/304D by alloying with very high nitrogen (above 2000MPa), the same amount of chromium (18%) and lower nickel (~3%) but higher copper (1.70%) as compared with 304. QN1803/304D has higher pitting potential, lower pitting corrosion rate, higher yield and tensile strength and hardness and similar LDR compared to 304. Those good properties give QN1803/304D a very good platform to replace 304 in many application fields. The invention patent for QN1803/304D product has been applied. Until now, over 10,000 tonnes have been produced.

Name of Member:

Tsingshan Industry

Manufacturer:

Tsing Tuo Group Co.,Ltd, a Tsingshan Holding Company

Location:

Ningde City, Fujian Province, the People's Republic of China

Environment:

urban, rural, industrial, indoor

Grade and surface:

QN1803/304D - No.4/2B/NO.1

Competing materials:

S30408, S30403

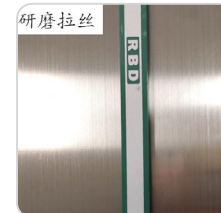
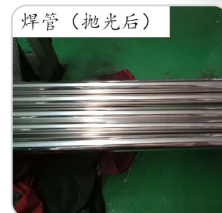
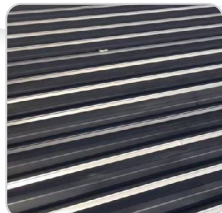

Pictures courtesy of Tsingshan Industry

Other



Urban waste sorting/recovery container

This kind of developments enhances stainless steel sustainability, being not only sustainable itself but also contributing to sustainable applications in order to preserve our environment. The application creates a new market for stainless steel and gives solutions to the multiple problems that waste containers can suffer, stressing the idea that waste can and must be sorted and recovered.

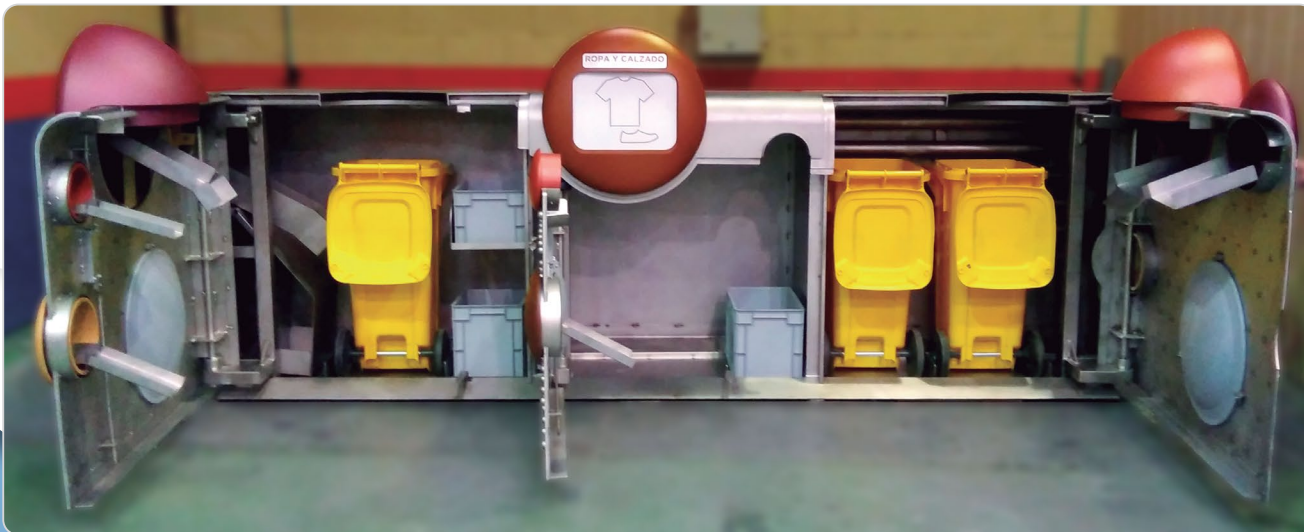
Name of member:

Acerinox

Manufacturer:
Porras Guadiana
Architects
Location:

Madrid, Spain

Environment:

urban

Grade and surface:

AISI 316 Finish No1

Competing materials:
galvanized steel or
plastics

Other

Stainless steel floors for bumper cars

There are many uses of stainless steel in the public space: both in Europe and outside of Europe it is now used in all kinds of spaces. The application shown here is interesting, innovative and very original. The floor is made from stainless steel sheet EN 1.4401 (AISI 316) with a 2B finish and a thickness of 3.5 mm, to give good consistency and good resistance to wear. An Italian company has created a new special project within SNOW PARKS: it is the classic "bumper car" model FPU-FLOOR PICK UP SYSTEM, in a version with a fully electrified floor with direct current. Given the particular location, the materials were asked to have good mechanical properties at temperatures of at least -10°C.



Name of member:

Centro Inox

Manufacturer:

I.E.Park S.r.l. SOLI
BUMPER CARS - via
Don P.Borghesi 3 - I-42043
Gattatico - Reggio
Emilia - Italy. Tel.
+39.0522.1678695 -
info@iepark.com -
iepark.com

Location:

Dubai, UAE

Environment:

indoor

Grade and surface:

EN 1.4401 (AISI 316),
2B finish

Pictures courtesy of Centro Inox

Other



Stainless steel new applications in Nigeria

Stainless steel grade 304 is widely use in Nigeria. However, it faces fierce competition from Aluminium and Foreign Wrought Iron especially in the southern and western region of Nigeria because of the terrain. The water in those regions contain high levels of salt, so most users who domicile there prefer to use Aluminium or Foreign Wrought Iron material ONLY for their handrails instead of Stainless steel grade 304.

Nevertheless, the stainless steel market is under developed because all the stainless steel materials we consume are imported and the demand of stainless steel is increasing geometrically because of the wide range of applications.

Lastly, stainless steel grade 304 is affordable compared to stainless steel grade 316 and it has the ability to fight corrosion efficiently.

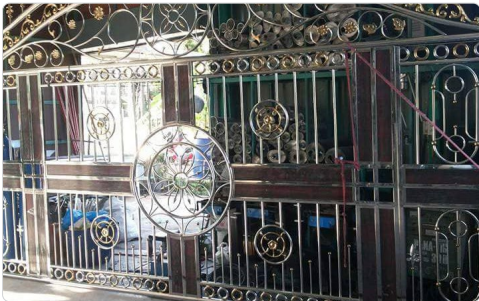

Name of member:

SSDAN

Location:

Lagos and Abuja,
Nigeria

Environment:

urban, rural, indoor

Grade and surface:

grade 304, polish
(mirror)

Competing materials:

steel (foreign wrought
iron) and aluminium

Pictures courtesy of the Stainless Steel Development Association of Nigeria

Other

RFID applied stainless steel food waste measuring & paying equipment

Most Koreans live in apartment complexes which have recycling facilities located in communal areas. Each family residing in an apartment complex is able to dispose of their personal food waste into communal food waste bins. These bins use Radio Frequency Identification Devices (RFID) to weigh the waste produced and to charge residents a fee. Stainless steel bins made with STS 304/329 are ideally suited to collect food waste. High salinity and acidity of food is known to contribute to the surface corrosion of the current food waste bins coated with Electrolytically Galvanized

Steel (EGI) over time. In addition, lengthy exposure to the outside elements may also further damage EGI-coated bins. These food waste bins made with STS 304/329 are not as susceptible to rust due to the absence of a coated surface. As such, the structural integrity of these bins can endure over a longer period than EGI-coated bins. The longer durability and easy maintenance of these bins make them a more attractive option to buyers. With communal food waste bins commonly found in apartment complexes throughout Korea and with the increasing awareness of recycling and conscious disposal of waste, there is the opportunity for stainless steel to be used in the food waste area.

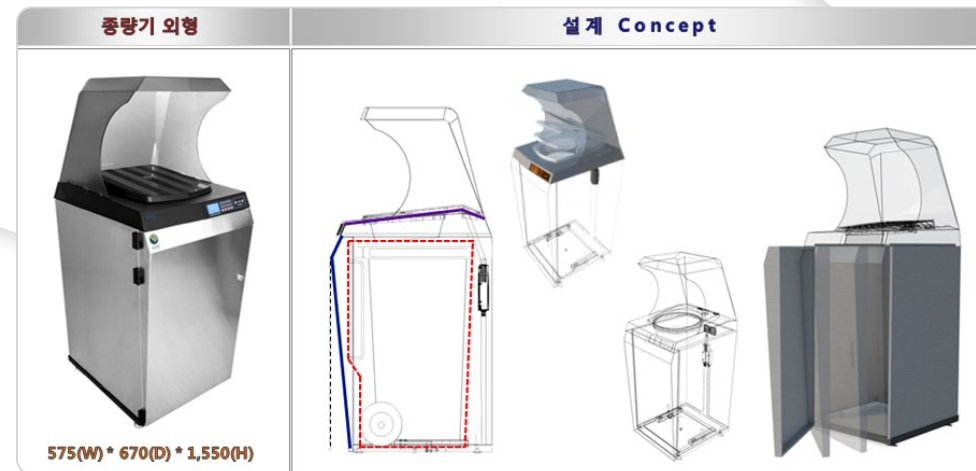

Name of member:
KOSA
Manufacturer:
Tri-s (tri-s.co.kr)
Location:
Gyeonggi-do, South Korea
Environment:
urban
Grade and surface:
STS304/329
Competing material:
EGI (Electrolytic Galvanized Iron)

Pictures courtesy of the Korea Iron and Steel Association

Other

Stainless steel leading the way to a safe and sustainable future

1. Bread Moulds

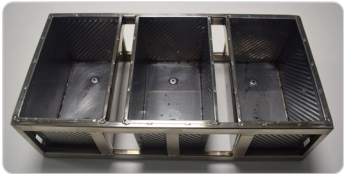

A thick coating of white flour and oil gets stuck to the mild steel & aluminium mould and becomes black in colour. Ferritic

Grade 430 stainless steel (0.6 mm thickness) mould was developed and baking was achieved with the same parameters and moreover moulds could be cleaned well, making it more hygienic and safe. This will open a good potential for usage of stainless steel in the Baking Industry.

2. Electric Rickshaws



In India, electric battery rickshaws are developed and are running to last 5 years. Stainless Steel structural and decorative pipes were used to build the entire rickshaw in 200 series. Also the

floor and seats of the rickshaw were built in stainless steel and laser cut designs were used to improve the aesthetics of the vehicle. This helped in reducing weight of the rickshaw due to reduction in thicknesses of the pipes used, increased the strength of the vehicle and improved the aesthetic aspects of the vehicle. With these changes, we are expecting to double the life of a rickshaw and the efficiency of the vehicle will also be increased due to less weight.

3. Fish Rearing Cage



The cages built in mild steel, wooden structures float in the sea to store fish and over a period of time, get rusted or weaken due to

salty or high moisture content. The entire Grade 304 stainless steel cage (thickness of 1 mm pipe structure) were developed and chequered floors were used on the sides to provide a platform for fishermen. We expect the life of the structure will increase 3 times with the usage of stainless steel, reducing corrosion on the structure.

4. Display and Training Vehicle



We have developed 2 display vans in stainless steel. These vans showcase the usage of stainless steel in household

products i.e. Kitchen & Utensils, Water applications e.g. Overhead water tanks & plumbing pipes, Decor-Cabinets, showcases, etc & study area i.e. furniture, table ware etc. All these applications were displayed in a mobile van comprising of 21 feet display area. Moreover special PVD finishes and chequered floors are also displayed in the van. This van is also equipped with welding and finishing tools to train fabricators on site. These vans are being extensively used for training and display purposes and are also becoming part of various exhibitions and conferences. We have trained more than 8000 fabricators in 85 cities across the Indian subcontinent in the last 2 years.



Name of member:

ISSDA

Manufacturer:

Jindal Stainless Ltd.

Environment:

urban

Grade and surface:

430 (bread moulds),
E-rickshaw (304), Fish
Cages (304), Display
Van (304)

Competing material:

carbon steel

Pictures courtesy of the Indian Stainless Steel Development Association

Other

SP-JOINT fire plug granular tee, customized fire pipe multi-joint tee

Previously, copper or steel pipes had to be punched or fabricated a hole in order to connect with a branch pipe through welding. Dasung Tech's SP-JOINT Branch Tee is a customized, multi-joint Tee that is not only exclusive to fire piping but also removes the need of welding. Lower payroll costs yet more corrosion-resistant and safer.

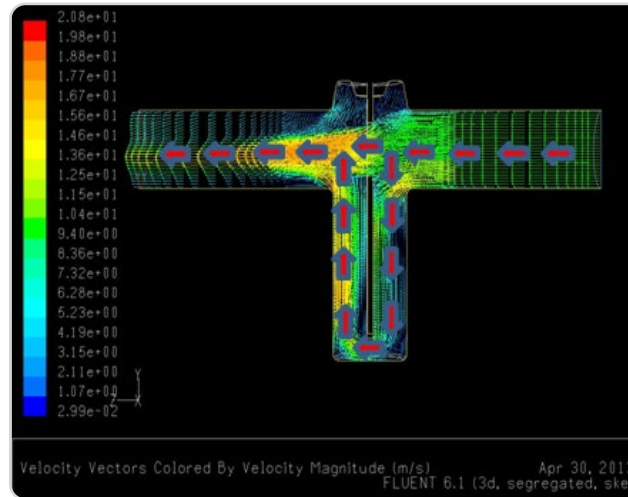

Pictures courtesy of Dasungtech Co. Ltd.



Name of member:
Korea Iron and Steel
Association
Manufacturer:
DASUNGTECH Co. LTD
Location:
Republic of Korea
Environment:
Indoor
Grade and surface:
STS304

Other

KAGRA, Large-scale Cryogenic Gravitational-wave Telescope of Japan

"KAGRA" is the large-scale cryogenic gravitational wave telescope in Japan, as the third gravitational-wave detector in the world, following LIGO in the United States and Virgo in Italy.

Approximately 800 tons of NSSC's high-performance austenitic stainless steel is applied to the laser interferometer which is the vital part of KAGRA to detect an extremely small space-time distortion occurred by gravitational waves. The laser interferometer is to measure the difference of length of two split laser beams passing the same distance after generated from one source. The two 3,000 meters-long ducts where the two laser beams pass through orthogonally are welded pipes made of SUS304L. It is an ultra-high vacuum condition inside and the air pressure is just 1/100,000,000,000 of the atmosphere.

NSSC130S* is used for "Recoil Mass" which holds sapphire mirrors and is attached to the control device in the extremely cold condition, of -253°C. Several measures have been implemented to eliminate all possible noise which might disturb the detection, because the distortion caused by gravitational waves is just 10-19 m when it reaches the earth. KAGRA was installed at least 200m below the ground surface to avoid the influence of noise from the ground. Moreover, it has adopted cutting-edge technology to cool down the sapphire mirrors to cryogenic temperatures (-253°C) to reduce thermal noise at the molecular level.

Name of member:

NIPPON STEEL Stainless Steel Corporation

Owner:

Inter-University Research Institute Corporation High Energy Accelerator Research Organization/KEK; and Institute for Cosmic Ray Research, The University of Tokyo/ICRR

Location:

Kamioka Town Hida City, Gifu Pref. Japan

Environment:

indoor; ultra high vacuum cryogenic

Grade and surface:

1. Hot forged stainless steel round shape for "Recoil Mass"; Recoil Mass is attached to the controlling device to hold the sapphire mirrors, which are one of the most important parts of the laser interferometer to detect a space-time distortion. Grade: NSSC130S (18Cr-6Ni-11Mn-0.3N, similar to ASTM A666 XM-11) Weight: 200kg x 4 pieces
 2. Cold rolled stainless steel sheet for welded pipes
Grade: SUS304, No. 2B finish, 4.5mm thickness; Weight: Approx. 130 tons
 3. Stainless steel plate for welded pipes
 - 1) Welded stainless steel pipes for ultra-high vacuum duct
Grade: SUS304L, #150 electro-polishing for inner surface; Weight: Approx. 600 tons
Grade: SUS304, #150 electro-polishing for inner surface; Weight: Approx. 20 tons
 - 2) Welded stainless steel pipes for the Cryostat (a vessel whose inside is cryogenic and highly evacuated); Grade: SUS304, #150 electro-polishing for inner surface; Weight: Approx. 60tons
- Total amount of stainless steel from NIPPON STEEL Stainless Steel Corporation
Approx. 800 tons.



Other

KAGRA, Large-scale Cryogenic Gravitational-wave Telescope of Japan (cont.)

NSSC's stainless steel used in this project has met the tough requirements to support these advanced technologies, including non-magnetic stability in cryogenic temperature.

*NSSC130S (YUS130S) was also applied to the collars for dipole magnets of Large Hadron Collider (LHC) of the European Organization for Nuclear Research (CERN), which helped to discover Higgs boson. The discoverers, Prof. François Englert and Prof. Peter W. Higgs, were awarded Nobel Prize in physics in 2013.



Schematic underground view of the KAGRA facility



Ultra-high vacuum stainless steel duct of 3,000m in length, as the laser light path in the interferometer



Cryostat (as a container for high purity single crystal sapphire mirror)

Other

KAGRA, Large-scale Cryogenic Gravitational-wave Telescope of Japan (cont.)

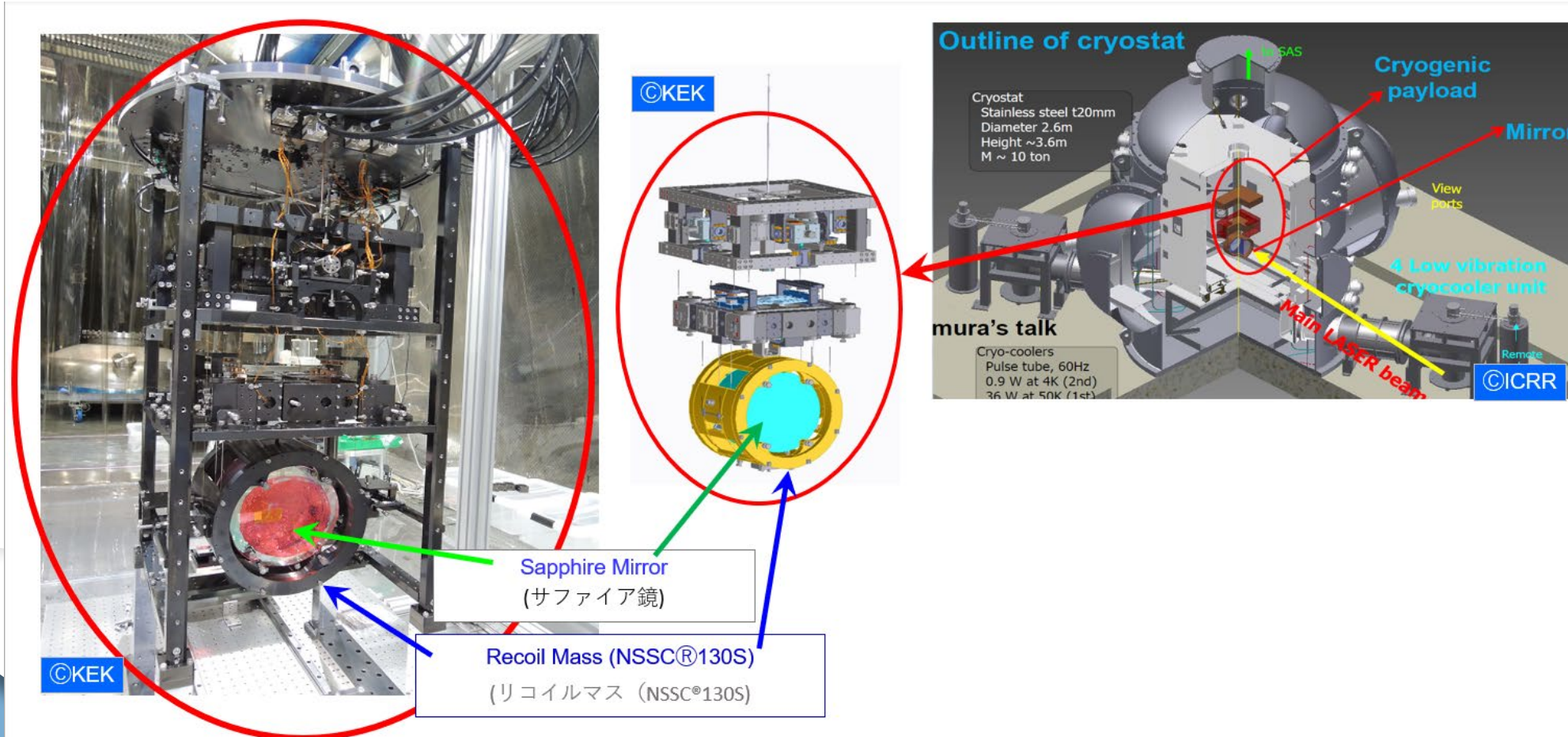

Schematic illustration of Cryostat, Sapphire mirror, and its recoil mass made of NSSC®130S

worldstainless.org